

AE-100

Commercial Telephone Entry System



Installation and Programming Instructions

Linear[®]
Building On Innovation.

USA & Canada (800) 421-1587 & (800) 392-0123
(760) 438-7000 - Toll Free FAX (800) 468-1340
www.linearcorp.com

Contents

Introduction.....	2	Programming Over the Telephone.....	15
Hardware Features.....	2	Multi-unit Installations.....	16
Software Highlights.....	2	Changing the Master Password.....	16
Feature Overview.....	3	Resident Data Programming.....	17
Operation.....	3	Stand-alone Entry Code Programming... 18	
Database Overview.....	3	System Options.....	18
Component Locations.....	4	System Options (Continued).....	19
Wiring Diagram.....	5	System Options (Continued).....	20
Important Mounting Requirements.....	6	System Utility Commands.....	21
Entry System Mounting.....	7	System Utility Commands (Continued)... 22	
Entry System Mounting (Continued).....	8	Alternate Programming Section.....	23
Access Relay Wiring.....	9	Alternate Programming Reference.....	24
Telephone Wiring.....	9	System Adjustments.....	32
Multiple Unit Telephone Wiring.....	10	System Diagnostics.....	32
Power, Battery, & Ground Wiring.....	11	AE-100 Operation.....	33
Optional Postal Lock.....	12	Specifications.....	34
Optional Color CCTV Camera.....	12	Dimension Drawing.....	34
Programming Reference & Factory Defaults.....	13	Accessories.....	34
Access to Programming.....	14	Troubleshooting.....	35
Programming from the Keypad (Standard Method).....	14	Linear Limited Warranty.....	35
		FCC Notice.....	35

Introduction

The Model AE-100 Commercial Telephone Entry System is designed for use as an access control device for small apartments or gated communities with up to 125 residents. The system can be used in a lobby or outside. Surface, recessed, and pedestal mounting options are supported. The system utilizes hands-free, full duplex telephone communications between visitors and residents for granting access.

Housed in a locked, rugged stainless steel faced enclosure, the AE-100 features a lighted 12-key telephone style keypad and four operation buttons all with bright, easy-to-see graphics. The backlit two-line directory LCD display scrolls a programmable welcome message and shows the directory Names and Directory Codes. The system contains a built-in microphone, tamper resistant speaker, and a TTY connector for the hearing impaired.

The heavy duty access relay can control electric door strikes, magnetic locks, door & gate operators, or barrier gates.

Multi-lingual display programming prompts and voice help is available with a choice of English, Spanish, French-Canadian, or Portuguese language selection for the system. The system can be programmed locally using the keypad, or remotely with a touch tone telephone.

Instruction manuals and other support documents in Spanish, French-Canadian, and Portuguese are available on the Linear Web site's AE-100 product page at www.linearcorp.com.

Optional features that the AE-100 supports are provisions for postal lock and color CCTV camera installation.

The AE-100 is powered from a 16 VAC plug-in transformer and supports an internal rechargeable 1.2 amp/hour backup battery (not included). The battery charging circuit will support an external backup battery with up to 7 amp/hour capacity.

Before starting the installation, please read and understand these instructions. Become familiar with the illustrations and wiring diagrams. They will be a guide to installing the system in an efficient and professional manner.

Hardware Features

- ✓ **2-LINE, 16-CHARACTER-PER-LINE LCD DISPLAY**
LED backlit display with easy-to-read .3" high characters
- ✓ **HEAVY DUTY FORM "C" (N.O. & N.C.) ACCESS RELAY**
Relay has 10-amp AC & 7-amp DC @ 30 Volts rating
- ✓ **POSTAL SWITCH OPTION**
Cabinet supports mounting a standard U.S.P.S. postal switch for mail carrier access
- ✓ **BUILT-IN ANNUNCIATOR**
Programmable for beeps during access and chirps during keystrokes
- ✓ **SMART BACKUP BATTERY CHARGING CIRCUIT**
Automatic load shed disconnects the backup battery if battery voltage drops too low
- ✓ **TTY JACK**
Front panel connection for TTY text communications device for the hearing impaired
- ✓ **OPTIONAL COLOR CCTV CAMERA**
System supports a Model CCM-1 color CCD camera for viewing the visitor area
- ✓ **FLEXIBLE TELEPHONE LINE CONNECTION**
Telephone line can connect to on-board RJ-11 jack or terminal block
- ✓ **REMOVABLE TERMINAL BLOCKS**
All terminal blocks are removable for quick servicing
- ✓ **TRIM RING FOR RECESS MOUNTING**
System can be mounted recessed using the optional Model TR-100 trim ring

Software Highlights

- ✓ **AUTOMATIC DUAL PROGRAMMING METHODS**
The system automatically recognizes two methods of programming to aid installers already familiar with programming other manufacturer's access control systems
- ✓ **LOCALLY PROGRAMMABLE**
All programming can be performed from the unit's keypad
- ✓ **REMOTE TELEPHONE PROGRAMMING**
Most programming can be performed with a TouchTone™ telephone over the phone line
- ✓ **125 RESIDENT DIRECTORY CAPACITY**
Up to 125 residents can have a directory listing
- ✓ **125 STAND-ALONE ENTRY CODES**
Up to 125 Stand-alone Entry Codes without a Directory Entry can be used for gaining access (Each Stand-alone Entry Code used reduces the number of available resident Directory Entries by one).
- ✓ **4 DIGIT ENTRY CODE LENGTH**
4-digit length for all Entry Codes
- ✓ **MANUAL ACCESS RELAY OPERATION**
Access relay can be activated indefinitely or for a set period of time
- ✓ **2-3 DIGIT DIRECTORY NUMBER LENGTH**
Directory Number lengths can be customized for small or large installations
- ✓ **MULTIPLE UNIT SUPPORT**
Up to four AE-100 units can be connected to the same telephone line and share programming data using system utility commands.
- ✓ **RESIDENT CALL-BACK SUPPORT**
Residents can call the system to initiate 2-way communications with a visitor. (Single unit installations only.)

Feature Overview

Installer Friendly Programming

To make it easy for installers familiar with Linear's and other manufacturer's access control systems, two methods of programming are available. Step numbers or function codes that match other equipment help the installer to make quick programming changes with keystrokes they have used before.

Non-volatile Programming Memory

The AE-100's memory retains all Resident Data, Stand-alone Entry Codes, and system programming data, even without power.

Local Programming

All system programming options can be set from the AE-100's keypad. A computer or dedicated programmer is not required to completely configure the AE-100.

Telephone Programming

Most system programming options can be set using a standard TouchTone™ telephone. By calling the AE-100 from a telephone, and entering the programming password, programming options can be changed and system functions can be controlled.

Robust Access Relay

A 10-amp AC (7-amp DC) dry contact relay output is provided to activate access devices, such as door strikes, magnetic locks, automatic doors, barrier gates, and automatic sliding gates. An LED indicator displays the status of the relay.

Optional Postal Lock

The AE-100 cabinet has provisions for installing a U.S.P.S. postal lock for keyed mail carrier access. The postal lock itself is not supplied, it must be purchased from your local post office. When the postal lock is installed inside the front panel of the AE-100, it will press a microswitch when the postal key is turned, activating the access relay.

Optional Color CCTV Camera

Linear's Model CCM-1 (P/N ACP00904) CCTV camera can be installed inside the AE-100 Entry System. The camera provides a video signal for viewing the area in front of the entry system.

Battery Backup

The system supports a 12-volt battery backup for operation during power outage. The system charges the backup battery, an external battery charger is not required to maintain the battery. The AE-100 cabinet will hold a 1.2 amp/hour sealed lead-acid gel cell battery (P/N 100104). The battery charging circuitry will support up to a 7 amp/hour external battery.

Multiple Unit Installation Capability

Up to four AE-100 units can be connected to the same dedicated telephone line to form a simple network. Connecting multiple units allows transferring programming data (either the directory entries only or the entire memory's contents) from the "master" unit to the other sub-units.

Resident Call-back

The AE-100 can answer the telephone and switch to speakerphone mode if the telephone call is within 60 seconds of the last use of the AE-100. In case of a recently missed call, this feature gives residents the capability to talk to a visitor and grant access by using their entry code on the telephone's keys.

Operation

In a typical installation, the unit's memory is programmed with each resident's Directory Code, Name, Telephone Number, and Entry Code.

Arriving visitors use the ▲ or ▼ keys to view the Name and Directory Code for the desired resident. Upon entering the Directory Code, or pressing the Ⓜ button, the AE-100 will automatically dial the resident's Telephone Number and establish two-way voice communication between the visitor and the resident. The resident will then have the option to grant or deny access to the visitor by pressing a digit on their telephone. Residents simply enter their Entry Code for access.

In addition to the telephone entry, the AE-100 can grant access at the keypad using up to 125 Stand-alone Entry Codes not assigned to residents (**each Stand-alone Entry Code used reduces the number of available Directory Entries by one**).

For ADA compliance for the hearing impaired, a visitor can connect their TTY device to the jack in the face of the system. The visitor will be able to use their TTY device to communicate with the resident's TTY device during the telephone call.

Database Overview

Programming the AE-100 involves entering installation information into the system's memory. The system uses this information as a reference "database" to control the operation of the system.

Resident Directory Data

Up to 125 resident Names, Telephone Numbers, and Entry Codes can be set. Each resident entry is assigned a Directory Code. Directory Codes can be two or three digits in length (all will be the same length). The Directory Code is the number a visitor would enter to have the system call the resident (the resident currently displayed can also be contacted using the Ⓜ button). Each resident data entry also includes the resident's Telephone Number and a unique Entry Code for that resident.

RESIDENT DIRECTORY DATA (UP TO 125 RESIDENTS)

FOR EACH RESIDENT: DIRECTORY CODE (2 OR 3 DIGITS)
NAME (UP TO 16 CHARACTERS)
TELEPHONE # (UP TO 14 DIGITS)
ENTRY CODE (4 DIGITS)

Stand-alone Entry Code Data

Up to 125 Stand-alone Entry Codes ("Entry Codes" are called "Access Codes when using the alternate programming method) that are not assigned to a resident's directory listing can be set. These types of Entry Codes are useful for service and maintenance personnel. **Each Stand-alone Entry Code programmed reduces the available number of resident Directory Entries by one.** Stand-alone Entry Codes are four digits in length. When a Stand-alone Entry Code is entered at the keypad, it will activate the access relay.

STAND-ALONE ENTRY CODE DATA (UP TO 125 CODES)

FOR EACH CODE: STAND-ALONE ENTRY CODE (4 DIGITS)
NOTE: EACH STAND ALONE ENTRY CODE REDUCES THE AVAILABLE NUMBER OF RESIDENT DIRECTORY ENTRIES BY ONE

Component Locations

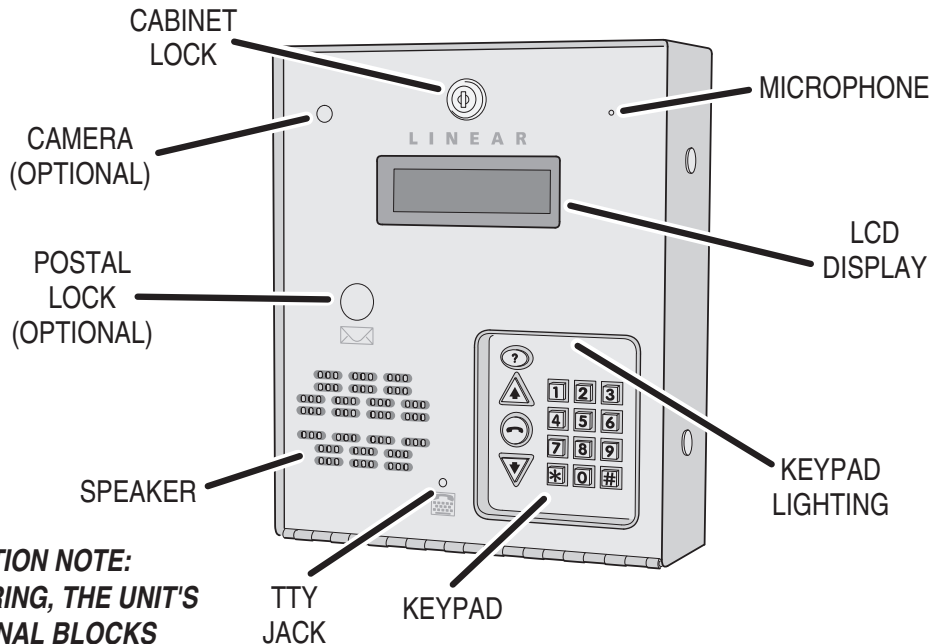

INSTALLATION NOTE:
FOR EASY WIRING, THE UNIT'S GREEN TERMINAL BLOCKS CAN BE UN-PLUGGED FROM THE CIRCUIT BOARD

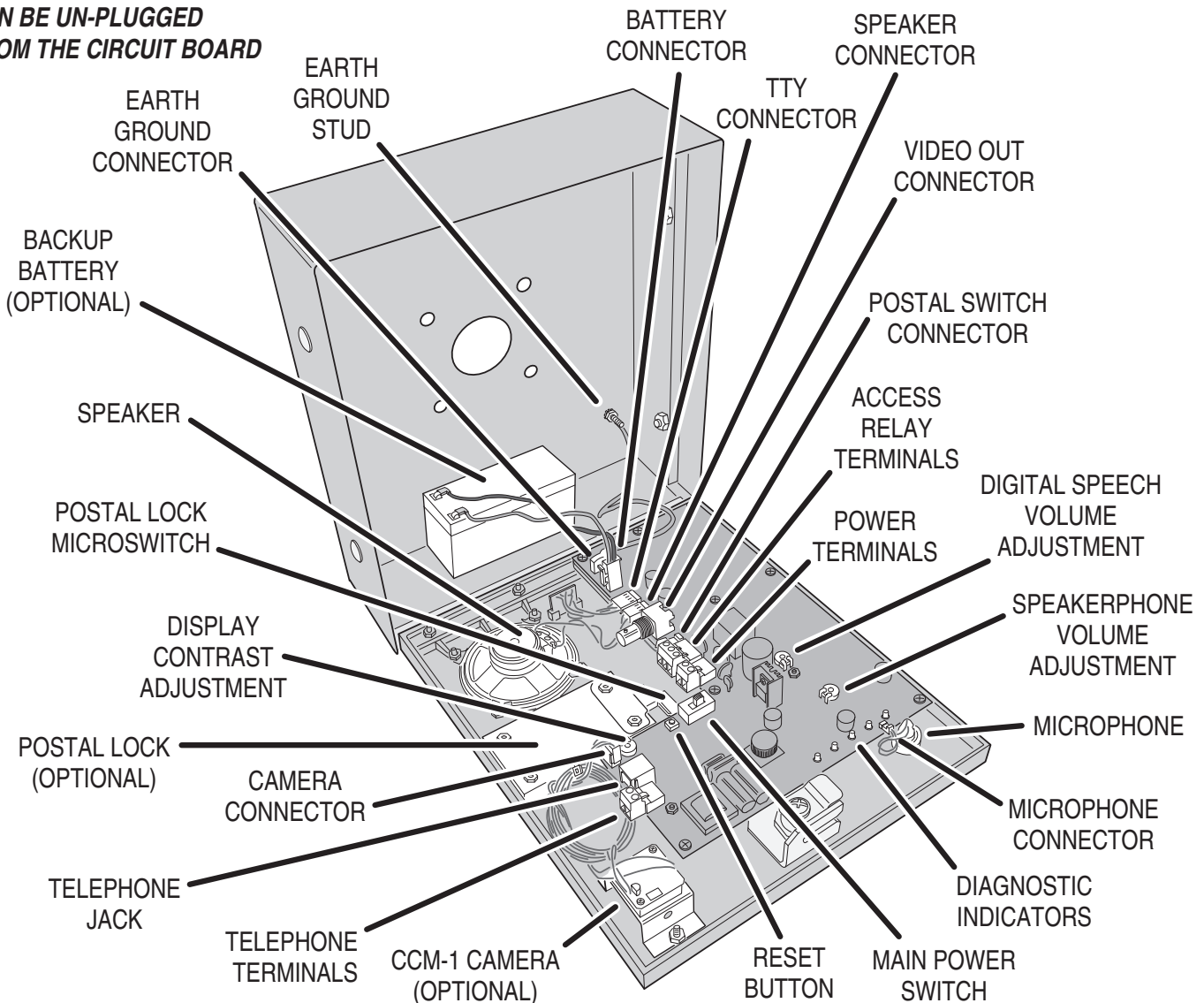

Wiring Diagram

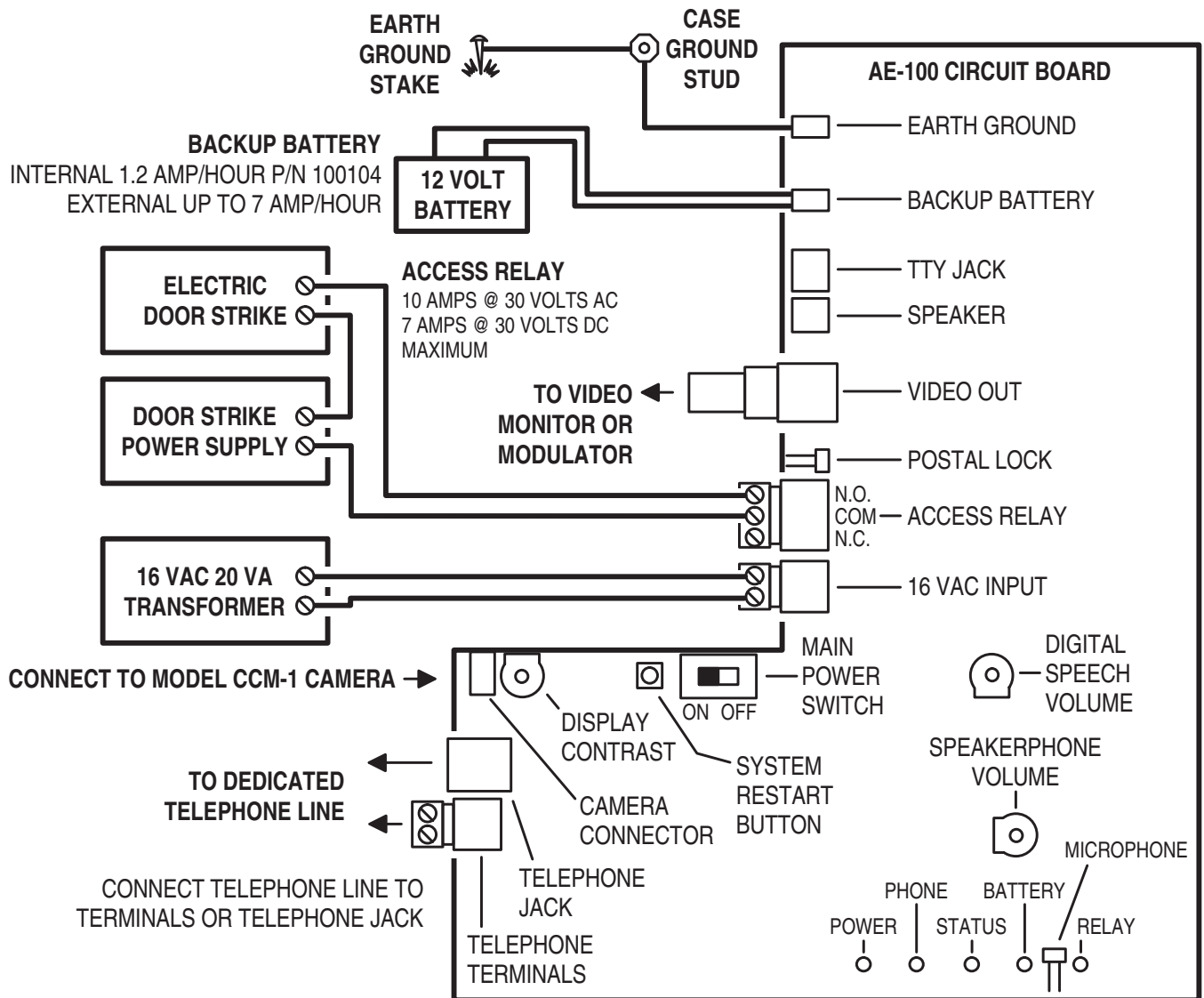

WIRING NOTES

1. FOR POWER TRANSFORMER WIRE RUNS UP TO 100 FEET USE 18 AWG, THHN 600-VOLT INSULATED WIRE
2. FOR POWER TRANSFORMER WIRE RUNS UP TO 200 FEET USE 16 AWG, THHN 600-VOLT INSULATED WIRE
3. DO NOT ROUTE THE TELEPHONE AND AC WIRING INSIDE THE SAME CONDUIT!
4. INTERNAL BATTERY CHARGER WILL SUPPORT UP TO A 7 AMP/HOUR BACKUP BATTERY
5. CONNECT THE CASE GROUND STUD TO A GOOD QUALITY EARTH GROUND WITH 12 AWG SOLID WIRE
6. DO NOT USE THE AE-100 TRANSFORMER TO POWER THE DOOR STRIKE!

Important Mounting Requirements

The AE-100 Telephone Entry System can be installed for public or private use. The mounting requirements will vary depending on the installation. Review the following information before beginning the installation.

Mounting Environment

Consider the environmental factors at the desired mounting location. The AE-100 is designed for direct outdoor installations, however, it is preferable to protect the unit from extreme exposure to sun, driving rain, or snow whenever possible. Mounting the unit in a kiosk can provide extra environmental protection.



Follow Building Codes

Check all local building codes and ordinances prior to installing the system. Proper installation of the AE-100 conforming to the local building codes for access control equipment is a regulatory requirement. The AE-100 installation is an extremely important and integral part of the overall access control system.

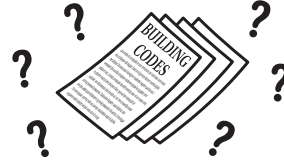

Mounting Location

If the AE-100 is used to control a door or pedestrian gate, locate the unit as near as practical to the entry point. If the unit is mounted on or in a wall adjacent to the entry point, be sure the wall is sturdy. The repeated shock and vibration from a slamming access door or spring-loaded pedestrian gate must be isolated from the AE-100. **NEVER MOUNT THE UNIT DIRECTLY TO A MOVING DOOR OR GATE!**

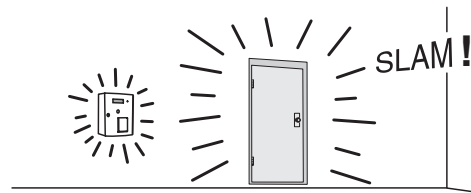

Gate Installations

If the AE-100 is used to control a gate operator connected to a vehicular gate, the unit **MUST** be mounted **AT LEAST 10 feet** away from the gate (open and closed) and gate operator. **AT NO TIME SHOULD A PERSON BE ABLE TO TOUCH THE GATE OR GATE OPERATOR AND THE AE-100 AT THE SAME TIME.**

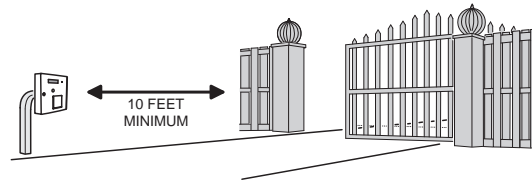

Vehicle Traffic

Do not mount the AE-100 where it extends into any traffic lane. Locate the gooseneck pedestal or entry kiosk so all parts of the AE-100 are outside the traffic lane. Locate the AE-100 clear of any turn-around lanes vehicles use when access is denied.

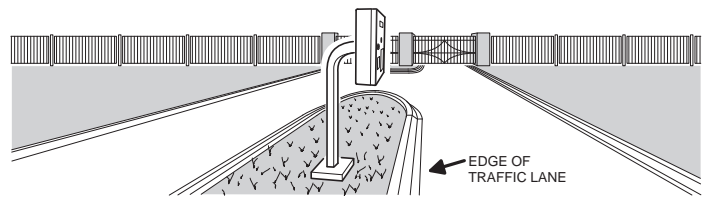

Americans with Disability Act (A.D.A.) Requirements

THE FOLLOWING WHEELCHAIR ACCESS REQUIREMENTS ARE FOR PUBLIC DOOR CONTROL INSTALLATIONS ONLY.

1. If the clear floor space allows only forward approach to the system, the maximum high forward reach allowed is 48" above grade to the top of the keypad.
2. If the high forward reach to the system is over an obstruction of greater than 20" but less than 25", the maximum high forward reach allowed is 44" above grade to the top of the keypad.
3. If the clear floor space allows parallel approach by a person in a wheelchair, the maximum high side reach shall be 54" above grade to the top of the keypad.
4. If the high side reach is over an obstruction of 24" or less, the maximum high side reach allowed is 46" above grade to the top of the keypad.



Entry System Mounting

The AE-100 cabinet is designed to be mounted three ways:

- The unit can be mounted directly to a wall or flat surface.
- The unit can be mounted recessed into a wall.
- The unit can be mounted on a standard goose-neck pedestal.

Choose a well lit location near the controlled opening. Wiring access for power, telephone, earth ground, and access output must be available to the mounting location.

Static Electricity Warning

The unit's main circuit board contains static sensitive electronic components that can be damaged or destroyed by static discharges during installation. Discharge the static electricity from your body by touching a grounded object before touching the unit's circuit board.

Surface Mounting

The cabinet can be mounted on a wall or any suitable flat surface. The four 3/8" mounting holes or any of the six self-drill locations can be used to attach the cabinet to the surface.

1. For wall mounting, hold the cabinet at the approximate mounting location where the display will be about eye level or slightly above (follow ADA mounting requirements in public installations).
- 2A. If using the 3/8" mounting holes, mark the four mounting hole centers. Drill as required. Use the appropriate fasteners for the mounting surface to secure the cabinet.
- 2B. If using the self-drill mounting holes, choose the correct size bit for the fasteners and drill the cabinet as required. Use the appropriate fasteners for the mounting surface to secure the cabinet.

◆ **CAUTION!:** After drilling, remove any metal chips from the inside of the cabinet.

Pedestal Mounting

The cabinet can be mounted on a standard goose-neck pedestal. Linear offers two types of pedestals. The Model GNC-1 is a 42" high curb-mount pedestal (P/N ACP00906), the Model GNB-1 is a 72" high burial-mount pedestal (P/N ACP00907).

1. Fish the wiring through the pedestal and install the pedestal at the desired location.
2. Route the wiring through the large cabinet hole.
3. Use security hardware to attach the cabinet to the pedestal.

External Alarm Contacts

In installations where vandalism is a concern, an internal normally closed alarm contact may be added as a tamper switch to the AE-100 providing a trigger source for an external alarm panel.

If the AE-100 cabinet is opened for any reason, the internal alarm contact will trigger the external alarm panel, reporting the alarm to a central monitoring station or other alarm reporting location. The alarm contact must be a UL Listed alarm switch using either a magnetic reed switch or plunger operated microswitch.

Insure that the additional switch components do not interfere with the door lock, optional CCTV camera, or other wiring internal to the AE-100.

◆ **NOTE:** Be sure that the locked AE-100 cabinet door makes a solid connection to the alarm switch so that false alarms do not occur if the unit is vibrated or shaken by the wind.

The typical location for the tamper switch is in the upper right corner of the AE-100 cabinet.

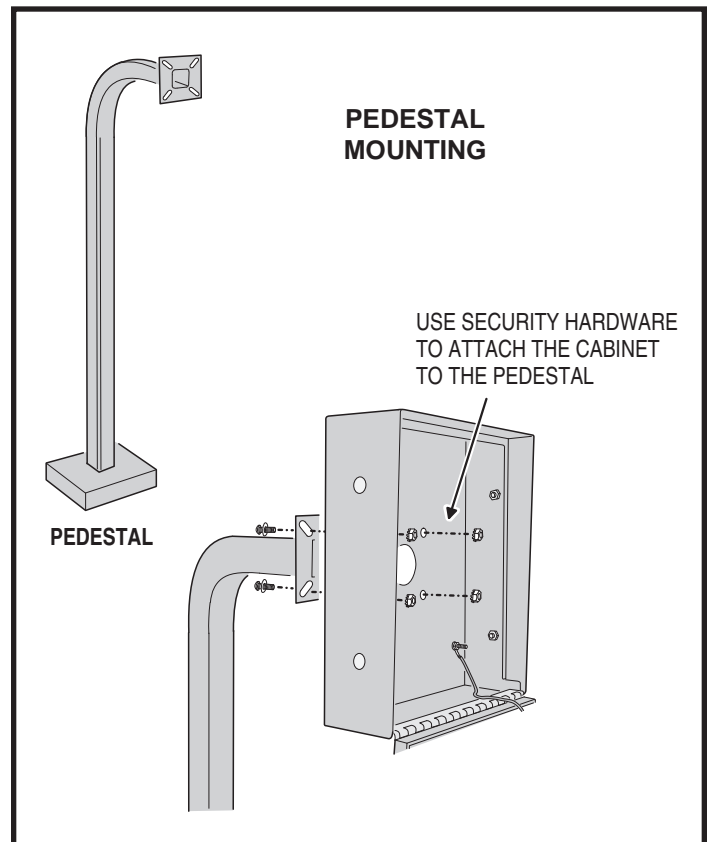
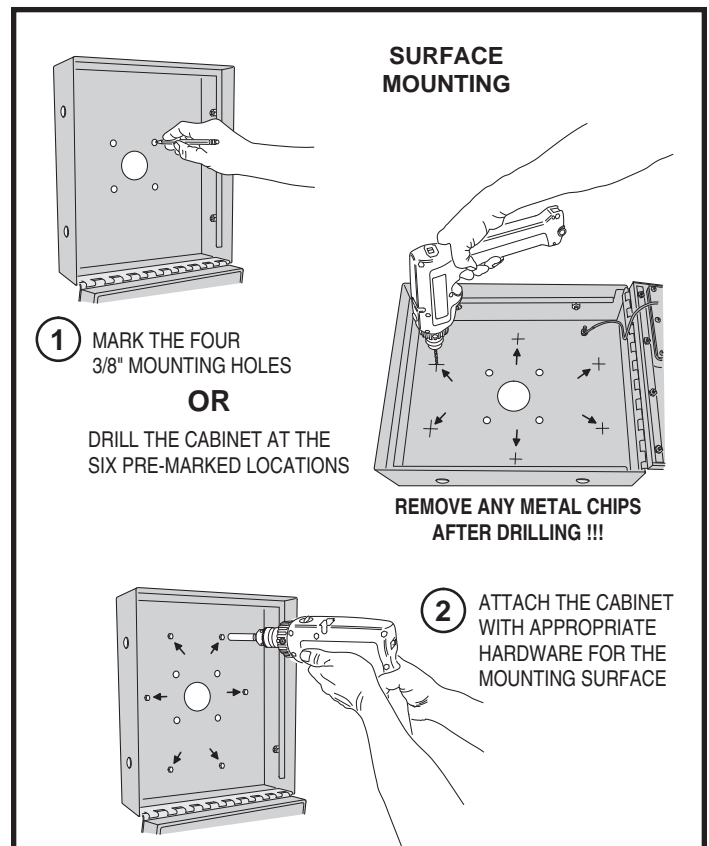

Entry System Mounting (Continued)

Recessed Mounting

The cabinet can be mounted recessed using the accessory trim-ring Model TR-100 (P/N ACP00941). The trim-ring mounts in the wall and the cabinet attaches to the trim-ring.

1. Identify the location of any studs in the wall.
◆ **CAUTION!:** Watch out for wiring inside the wall.
2. Determine and mark the 12" high by 10" wide hole location.
3. Cut the rectangular hole between studs at the mounting location.
4. Install any additional mounting shims required to provide surfaces inside the wall 10" apart for attaching the trim-ring.
5. Place the trim-ring in the wall hole. Check for level, then attach the trim-ring with four screws into the side tabs (the tabs can bend out a little to meet the shims if necessary).
6. Remove the four nuts and bolts that connect the cabinet's gray outer wrap to the cabinet. Remove the outer wrap piece.
7. Drill 3/16" holes in the cabinet's six pre-marked locations.
◆ **CAUTION!:** After drilling, remove any metal chips from the inside of the cabinet.
8. The trim ring is supplied with four adhesive mylar stickers. Apply these stickers to the cabinet's four bolt holes that were used to mount the outer wrap to the cabinet. The stickers will help to seal the cabinet sides from moisture and insects.
9. Route the wiring through the trim-ring and into the cabinet through the center wiring hole.
10. Attach the cabinet to the trim-ring using self-tapping screws supplied.

- 1 DETERMINE LOCATION FOR THE 10" x 12" MOUNTING HOLE

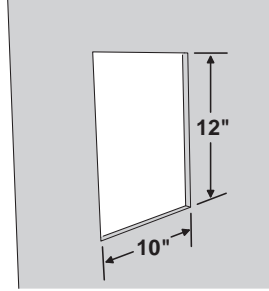

- 2 MARK HOLE LOCATION

RECESSED MOUNTING



- 3 CUT MOUNTING HOLE

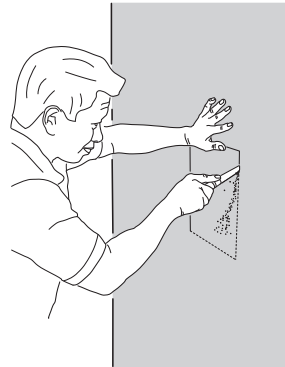

- 4 INSTALL ANY SHIMS TO ALLOW MOUNTING AND ATTACH THE TRIM-RING WITH 4 SCREWS

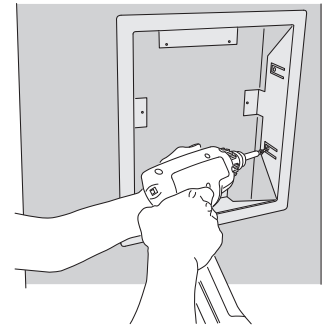

- 5 REMOVE THE FOUR OUTER WRAP BOLTS AND REMOVE THE CABINET'S OUTER WRAP

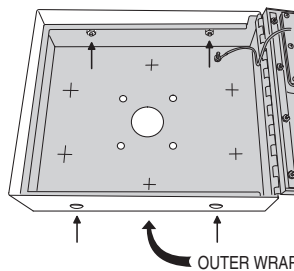

- 6 DRILL 3/16" HOLES IN THE CABINET AT THE PRE-MARKED LOCATIONS

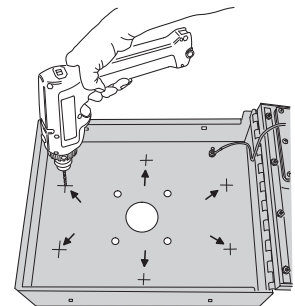

REMOVE ANY METAL CHIPS AFTER DRILLING !!!

- 7 APPLY THE FOUR MYLAR STICKERS TO THE BOLT HOLES

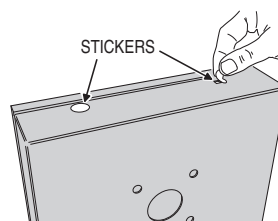

- 8 ATTACH THE CABINET TO THE TRIM-RING WITH SELF-TAPPING SCREWS

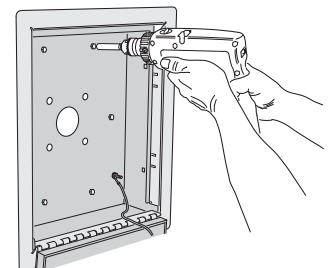

Access Relay Wiring

The access relay controls access devices, such as a door strike, magnetic lock, automatic door, barrier gates, or automatic sliding gate. The **RELAY** indicator displays the status of the relay.

Door or Pedestrian Gate Control

1. Install a low voltage electric door strike or magnetic lock as a locking device for the door or pedestrian gate.
2. Install the power supply or transformer for the locking device. **DO NOT POWER THE AE-100 FROM THIS POWER SUPPLY.**
3. Connect one wire from the power supply to one wire from the locking device.
4. Route two wires between the locking device and the AE-100. Connect one wire to the remaining wire of the locking device. Connect the other wire to the remaining wire of the power supply.
- 5A. For a door strike, connect the wires to the AE-100 access relay **COM** & **N.O.** terminals.
- 5B. For a magnetic lock, connect the wires to the AE-100 access relay **COM** & **N.C.** terminals.

Gate Control

1. Route two wires between the gate and the AE-100.
 2. Connect the gate operator's **OPEN** terminals to the AE-100 access relay **COM** & **N.O.** terminals.
- ◆ **NOTE:** For operator wiring specifics, refer to the gate operator's wiring diagram

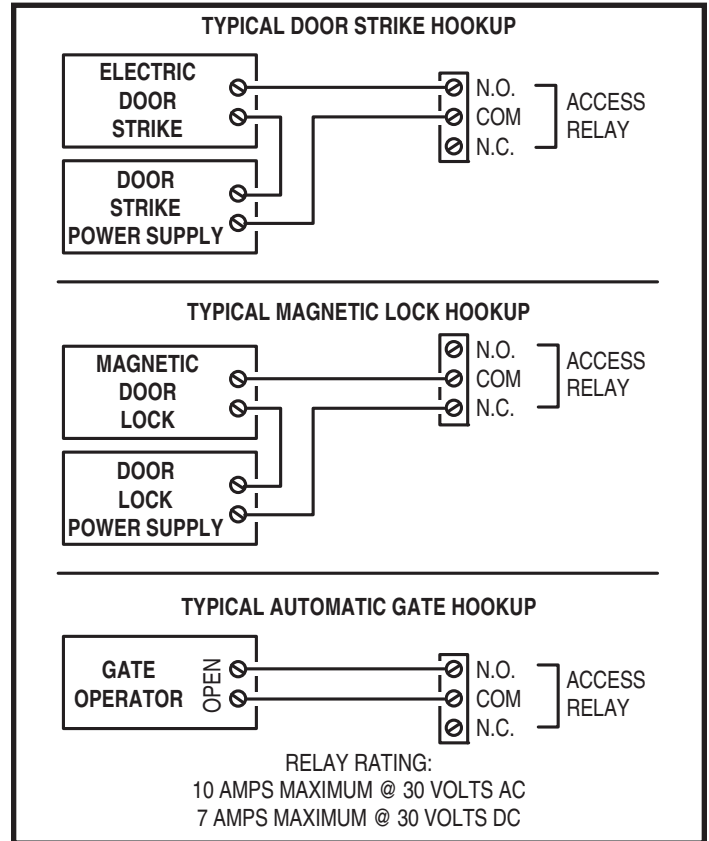

Telephone Wiring

For telephone entry and programming, the AE-100 connects to a standard telephone line. A dedicated telephone line is required.

- ◆ **NOTE:** For multiple-unit installations, also refer to the next section.

Important Telephone Wiring Tips

- DO NOT ROUTE TELEPHONE AND AC WIRING INSIDE THE SAME CONDUIT. Route all telephone wires inside a dedicated conduit that is at least six inches away from any AC line wiring.
- All telephone wiring must be made on the "building" side of the telephone company's demarcation device (the terminal block where the telephone line connects to the building).
- If any security system or personal alert system at the installation is connected to the telephone line, be sure that it is connected to the line ahead of the AE-100 using a RJ-31X or RJ-38X interface.
- Use only high-quality telephone wire. All telephone wire should be twisted-pair with a minimum size of 24 AWG.

Typical Telephone Wiring

- 1A. If using the AE-100 modular connector for the telephone connection, connect a double-ended modular cable between the AE-100's **TELEPHONE** jack and the modular telephone jack wired to the installation's telephone line.
- 1B. If using the AE-100 terminal block for the telephone connection, connect the two telephone wires to the two screw terminals (polarity either way).

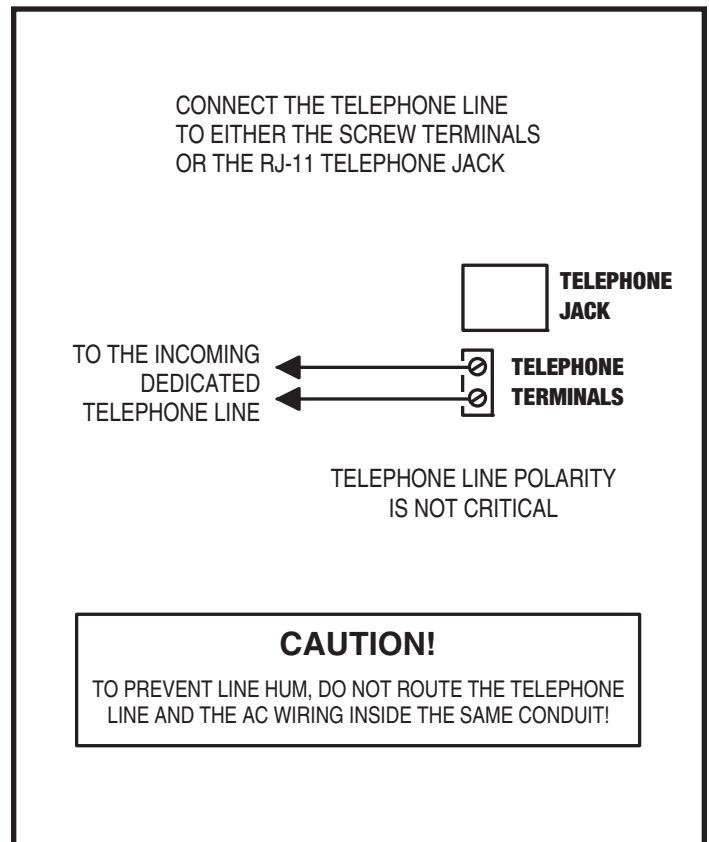

Multiple Unit Telephone Wiring

Up to four AE-100 units may be connected to the same dedicated telephone line to form a simple network. Connecting multiple units allows transferring programming data (either the directory entries only or the entire memory's contents) from the "master" unit to the other sub-units.

◆ **NOTE:** For a multiple-unit installation to function properly, be sure to set programming Steps #07 & #71

Multiple Units Home Run Wired

1. Mount and install the master and sub-units.
2. Choose one unit to be the "master" unit and act as the "hub". Usually this would be a centrally located or "main" unit.
3. Route 2-conductor telephone cable from the master unit to each of the sub-units (see figure).
4. Connect each sub-unit's 2-conductor telephone cable to its **TELEPHONE** terminals (polarity not important).
5. At the master unit, connect all the sub-unit 2-conductor telephone cables to the master unit's **TELEPHONE** terminals (polarity not important).

Multiple Units Daisy-chain Wired

1. Mount and install the master and sub-units.
2. Choose one unit to be the "master" unit. Usually this would be a centrally located or "main" unit.
3. Route 2-conductor telephone cable from the master unit to the closest sub-unit.
4. Route 2-conductor telephone cable from the sub-unit in Step 3 to the next sub-unit.
5. Repeat for all sub-units (see figure).
6. Connect the 2-conductor telephone cables to the **TELEPHONE** terminals in each unit (polarity not important).

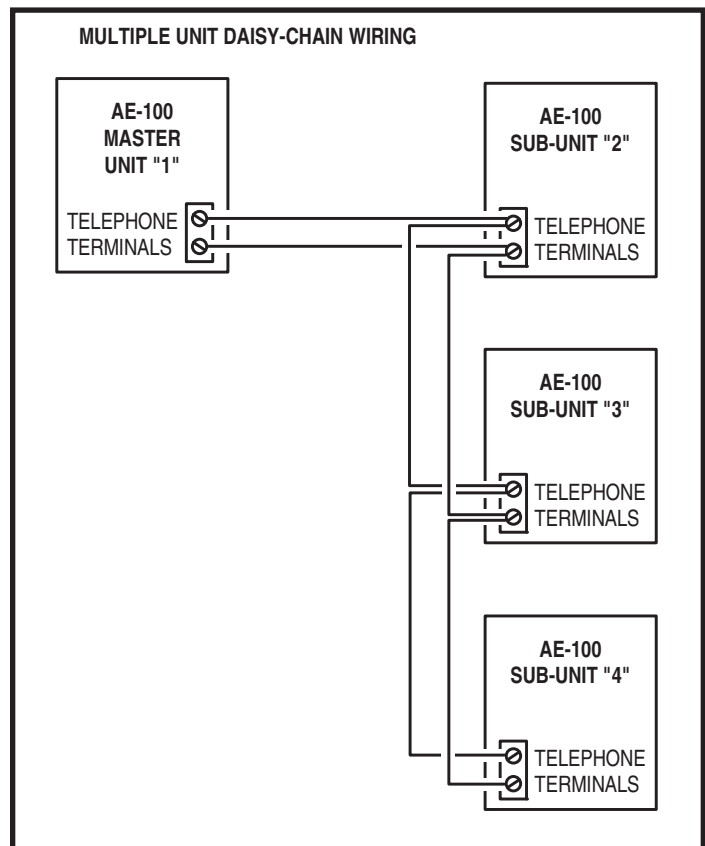
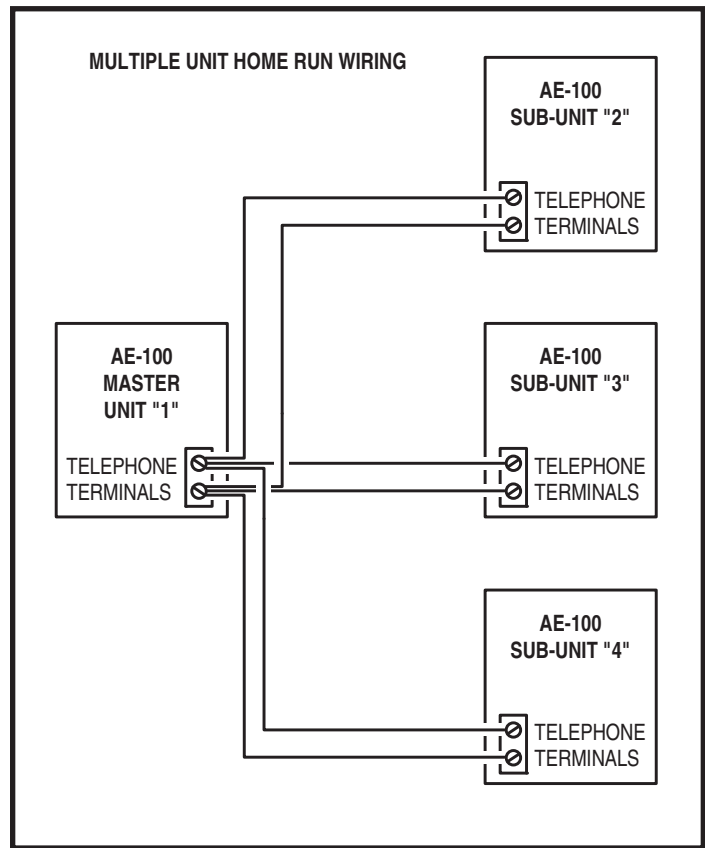

Power, Battery, & Ground Wiring

Power Wiring

◆ **NOTE: DO NOT APPLY POWER UNTIL THE INSTALLATION IS COMPLETE. TURN MAIN POWER SWITCH OFF BEFORE WIRING.**

1. Route two wires between the AE-100 and the power transformer.
 - For power wire runs up to 100 feet, use 18 AWG, THHN 600-volt insulated wire.
 - For power wire runs up to 200 feet, use 16 AWG, THHN 600-volt insulated wire.
2. Connect the wires to the transformer. Connect the other end of the wires to the AE-100 **16 VAC** terminals.

Backup Battery

Use of a battery backup is optional. It will allow the AE-100 to operate for short periods of time without AC power. The door or gate access device must use some type of battery backup of its own for the entire system to be functional.

A 1.2 amp/hour backup battery will fit into the AE-100 case. If using a larger external battery (up to 7 amp/hour capacity), protect the backup battery inside a rain-tight NEMA enclosure suitable for the installation and splice into the two AE-100 battery wires.

◆ **NOTE: A backup battery is not required to maintain the AE-100 programming memory during power outages.**

- 1A. For an internal backup battery, place the battery on the bottom of the AE-100 cabinet.

◆ **NOTE: UL Listing requires that the internal backup battery must be secured to the cabinet with double-stick tape or by using another secure method.**

- 1B. For an external backup battery, cut off the two spade lugs from the AE-100's battery wires. Route two red and black 18 AWG wires between the AE-100 and the backup battery location. Splice and insulate the wires to the AE-100's red and black battery wires. **OBSERVE POLARITY!** Use the two spade lugs from the AE-100 or new spade lugs to connect to the battery.
 2. Connect the battery positive to the **RED** wire.
 3. Connect the battery negative to the **BLACK** wire.

Earth Ground

For the best ground, use size 12 gauge solid wire or larger to connect the AE-100 to an 8-foot copper ground rod. Locate the ground rod next to the Power and Telephone company rods and bond the rods together with a new clamp. Do not disturb the clamps installed by the Power or Telephone Company. Alternately, connect to a cold water pipe for the earth ground.

1. Connect the wire from the earth ground to the AE-100's **CASE GROUND STUD**.

◆ **NOTE: The circuit board's GROUND terminal is internally connected to the EARTH GROUND STUD by a green ground wire.**

Main Power Switch

After the installation's wiring is complete, set the **MAIN POWER** switch to ON to apply power to the system for programming and testing.

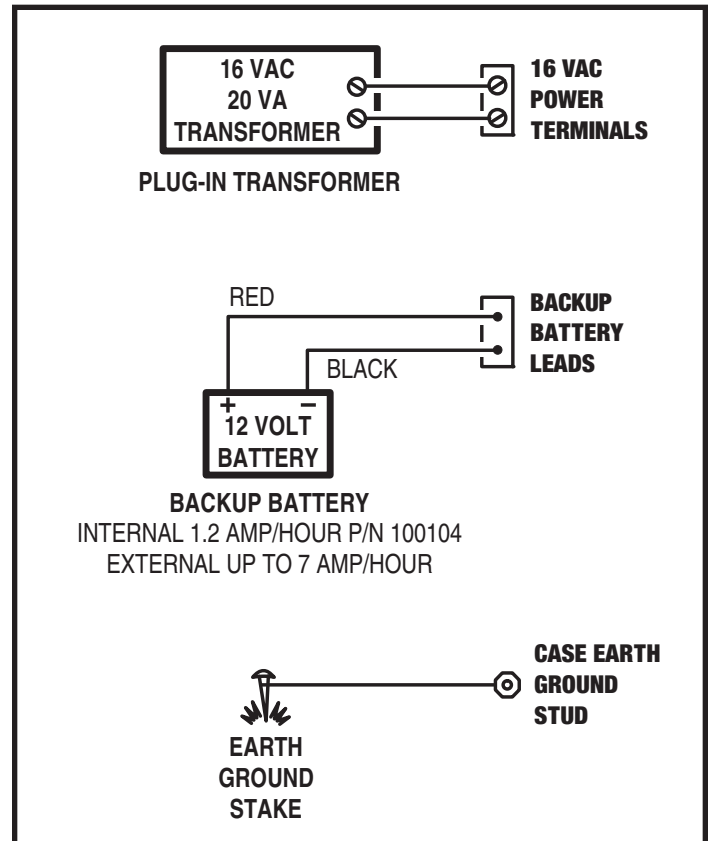

Optional Postal Lock

A postal lock can be installed in the AE-100 Entry System to provide keyed access for the postal service. The AE-100 case is designed to accept a U.S. Postal Service postal lock. When the postal lock is engaged the access relay will activate.

Postal Lock Installation

1. Remove the four locknuts that retain the postal lock cover plate and block (above the speaker on the AE-100 faceplate).
 2. Remove the cover plate and block from the four studs. Discard the plate and block.
 3. Remove the faceplate's postal lock hole plug. Discard the plug.
 4. Install the postal lock assembly onto the four studs. The postal lock's moving plunger should point towards the microswitch (see figure).
 5. Secure the postal lock with the four locknuts.
- ◆ **NOTE:** Be sure the postal lock's plunger actuates the microswitch. Adjust the postal lock and test the action until the microswitch fully actuates.
6. Tighten the four locknuts after the adjustment and testing is complete.

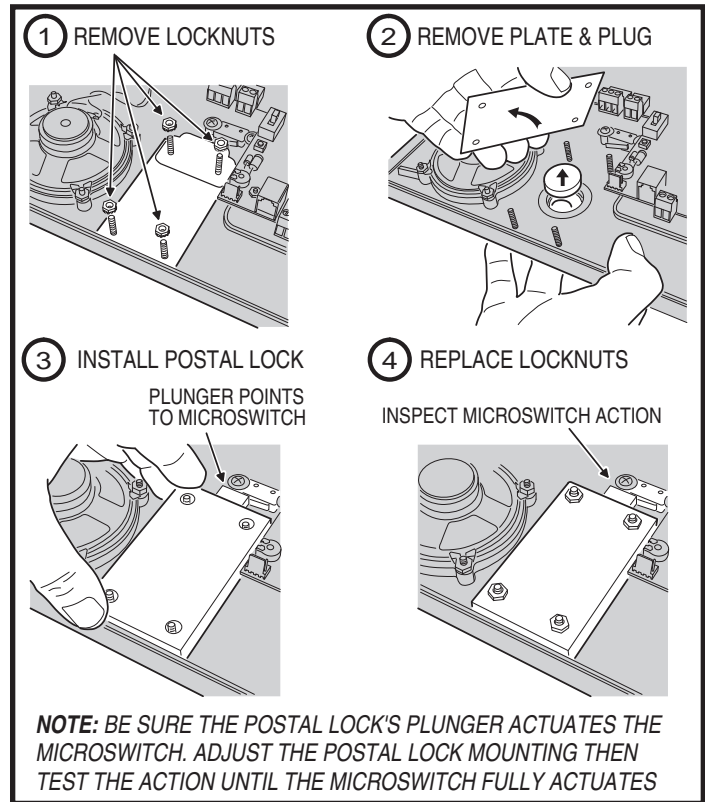

Optional Color CCTV Camera

Linear's Model CCM-1 (P/N ACP00904) CCTV camera can be installed inside the AE-100 Entry System. The camera provides a video signal for viewing the area in front of the entry system.

The **CAMERA** connector is used to connect the camera to the AE-100. The 4-conductor cable routes power to, and video from the camera.

The **VIDEO OUT** jack is the camera output for connection to a video cable with a Type "BNC" connector. Up to 400 feet of 75-ohm RG-59 video cable can be used. Longer cable runs may require the use of a video amplifier.

- ◆ **NOTE:** The composite video signal can be viewed on a video monitor. Alternately, a Linear ChannelPlus brand video modulator can be used to convert the video signal to an RF signal for installations where the camera's picture will be viewed on television sets tuned to a custom channel.

Camera Installation

1. Remove the two locknuts and the cover plate from the camera mounting studs on the AE-100 faceplate. Discard the cover plate.
- ◆ **NOTE:** A spare camera protection lens is supplied with the CCM-1 camera kit. If the AE-100's protection lens needs replacing due to vandalism, push the damaged protection lens out of the faceplate and install the spare protection lens before installing the camera.
2. Mount the camera assembly on the two studs, with the alignment hole in the camera bracket towards the top. Secure the camera with the two locknuts.
 3. Connect the camera's cable to the AE-100's **CAMERA** connector.
 4. Connect the video cable to the AE-100's **VIDEO OUT** connector.
 5. Connect the other end of the video cable to the viewing monitor, ChannelPlus brand video modulator, or video distribution system.

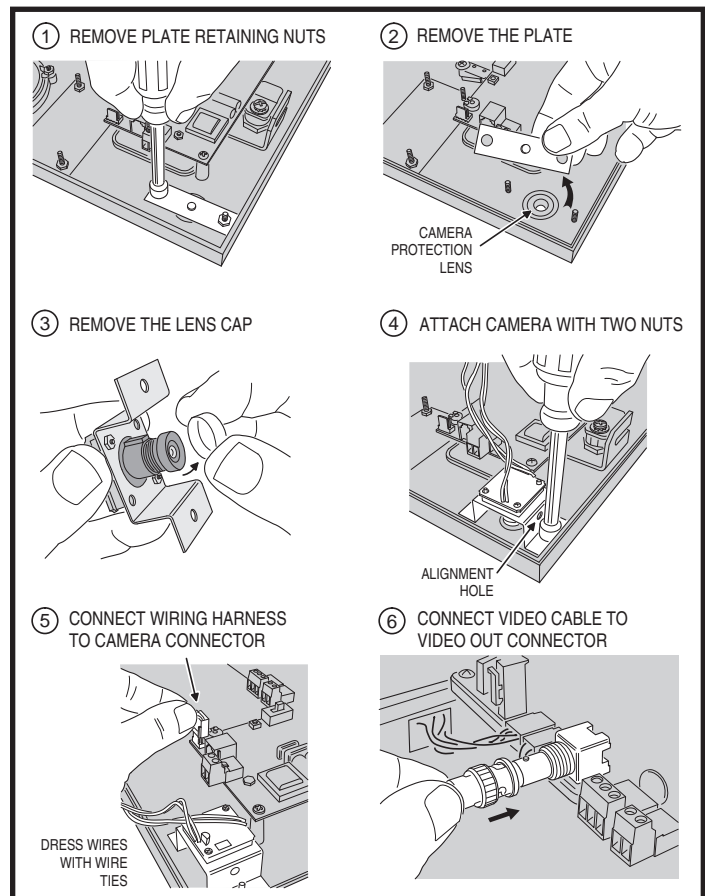

Programming Reference & Factory Defaults

STANDARD PROGRAMMING POSITION NUMBER	ALTERNATE FUNCTION CODE NUMBER	FUNCTION OF PROGRAMMING STEP	FACTORY DEFAULT VALUE
99	91	EXIT PROGRAM MODE	
SYSTEM OPTIONS			
01	00	CHANGE MASTER PASSWORD	123456
02	06	DIRECTORY CODE LENGTH	3
07	07	SET SUB-UNIT NUMBERS	NOT SET
38	38	SYSTEM DISPLAY LANGUAGE	ENGLISH
51	72	KEYPAD LOCKOUT COUNT	3 TRIES
52	71	ACCESS RELAY ACTIVATION TIME	4 SECONDS
57	10	WELCOME DISPLAY TEXT	LINEAR ACCESS TELEPHONE ENTRY
61	74	AUTOMATIC TELEPHONE ANSWER	ON
62	75	SPEAKER CHIRP ON KEYSTROKES	ON
63	76	SPEAKER TONE ON ACCESS RELAY ACTIVATION	ON
64	70	MAXIMUM VISITOR TALK TIME	60 SECONDS
71	08	ASSIGN UNIT NUMBER	1
77	77	RESIDENT CONTROL OF ACCESS RELAY	ON
95	95	RESIDENT CALL-BACK	OFF
ACCESS DATA CONTROL			
21	01	ADD A DIRECTORY ENTRY FOR A RESIDENT	
22	02	MODIFY AN EXISTING DIRECTORY ENTRY	
23	03	DELETE AN EXISTING DIRECTORY ENTRY	
31	31	ADD A STAND-ALONE ENTRY CODE	
33	33	DELETE A STAND-ALONE ENTRY CODE	
SYSTEM UTILITIES			
30	30	COPY ACCESS DATA ONLY FROM MASTER TO SUB-UNITS	
34	34	COPY ALL DATA FROM MASTER TO SUB-UNITS	
35	35	DISPLAY/CLEAR SYSTEM ERRORS	
37	37	POLL SUB-UNITS	
73	46	DISPLAY SYSTEM INFORMATION	
80	05	TIMED ACCESS RELAY LATCH	
81	05	LATCH ACCESS RELAY	
83	05	RELEASE ACCESS RELAY	
92	04	DELETE ALL RESIDENT DATA	
93	93	DELETE ALL STAND-ALONE ENTRY CODES	
200	50	TOTAL MEMORY RESET	

Access to Programming

To make it easy for installers familiar with Linear's and other manufacturer's access control systems, two methods of programming are available. Programming Position Numbers (or Function Codes) that match other equipment help the installer to make quick programming changes with keystrokes they've used before.

Automatic Programming Method Selection

The Programming Position Numbers (or Function Codes) change depending on the programming method used. Refer to the table on Page 13 for the numbers used for each programming method.

The keys used to enter programming from the unit's keypad select which programming method is used for the current programming session.

Entering programming by pressing **0** & **2** keys together will select the Standard Programming Method (Linear Access style). Details of each programming step when using the Standard Programming Method are shown on Pages 16-22.

Entering programming by pressing **0** & **#** keys together will select the Alternate Programming Method (other manufacturer's style). Details of each programming step when using the Alternate Programming Method are shown on Pages 23-31.

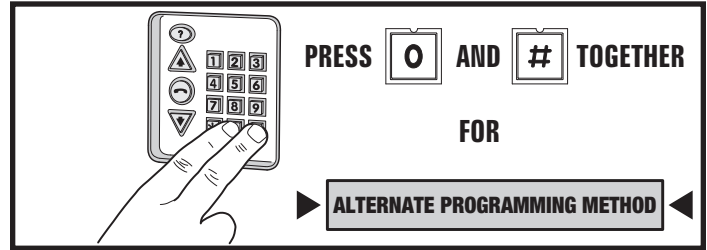
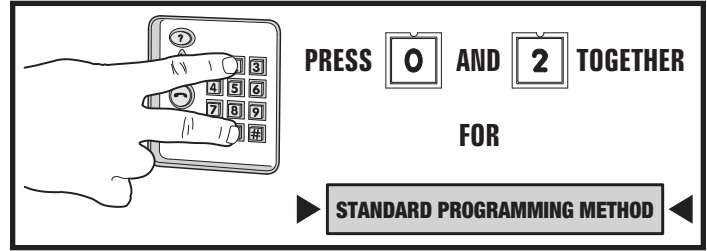

Programming from the Keypad (Standard Method)

The system can be programmed using the keypad on the faceplate of the AE-100. The display will show the programming information.

Accessing Programming from the Keypad

1. Press **0** & **2** keys at the same time, then release.
2. The display will show [PASSWORD:].
3. Enter the Master Password (factory setting is 123456).
4. Press: **#**
5. If the password is correct, the display will show [ENTER FUNCTION:].
6. Programming commands can now be entered on the keypad. Refer to the following sections of this manual for programming step details. Also refer to the figure for alphanumeric entry using the keypad.

Keypad Audio Prompts

When programming using the keypad, each programming step consists of entering programming data. **With the Standard Programming Method**, the system will sound beeps to indicate correct or incorrect entries.

- After a correct entry, two short beeps will sound.
- After an incorrect entry, one long beep will sound.
- After the complete programming step has been entered correctly, three short beeps will sound.

Re-entering a Command After a Mistake

If an incorrect entry, or an incorrect key is pressed during programming, to clear the keypad press ***** and start the programming step over again.

Exiting Programming Mode

1. Press: **9 9 #**
- ◆ **NOTE:** The AE-100 will automatically exit Programming Mode after two minutes of programming inactivity.

**KEYPAD ALPHANUMERIC ENTRY
(FOR PROGRAMMING STEPS REQUIRING TEXT)**

	a b c	d e f	g h i		
	[1]	[2]	[3]		
m n o					
	j k l	[4]	[5]	[6]	p q r
v w x					
	s t u	[7]	[8]	[9]	y z ,
backspace or erase entire line	[*]	[0]	[#]	finish entry	
		space, minus sign, dot			

- 1ST PRESS IS 1ST LETTER
- 2ND PRESS IS 2ND LETTER
- 3RD PRESS IS 3RD LETTER
- 4TH PRESS IS THE KEY NUMBER
- 5TH PRESS IS 1ST LETTER AGAIN

- WAIT 3 SECONDS FOR THE NEXT CHARACTER (A BEEP WILL SOUND AFTER THE 3 SECOND DELAY TIME) OR PRESS ANOTHER KEY
- THE FIRST LETTER OF EACH WORD WILL BE UPPER CASE, TO MAKE AN ENTIRE WORD UPPER CASE TEXT, ENTER # FIRST
- FINISH ENTRY BY ENTERING #
- PRESS STAR KEY TO BACKSPACE, PRESS STAR AGAIN TO ERASE LINE

Programming Over the Telephone

Most system commands can be programmed using a TouchTone™ telephone. The telephone's keypad will act similar to the AE-100's keypad. Both programming methods can be used over the telephone.

Connecting with a Telephone

- Place a call to the telephone number of the line that the AE-100 is connected to.
- The AE-100 will answer on the third ring.
- The system sounds beeps indicating the current system status (including any other units in a multi-unit installation):
 - One short beep sounds if all access relays are activated (all doors open).
 - Two short beeps sound if all access relays are deactivated (all doors closed).
 - One long beep sounds if there is a combination of access relays activated and deactivated (some doors open, some doors closed).
- Enter the unit number (1-4) of the unit to log onto then press **[#]**
In a single-unit installation, use the default unit number 1.
 - ◆ **NOTE:** Log on to the Master Unit #1 in a multi-unit installation to program the master's memory. The master's memory can then be copied to the other units.
- Enter the Master Password for the unit (the factory setting is 123456).
- To program using the Standard Programming Method press **[#]**
 To program using the Alternate Programming Method press **[*]**
 If the password is correct, the system will sound two short beeps.
- Programming commands can now be entered from the telephone's keypad.

To program the system, refer to the following pages of this manual.

- The Standard Programming Method steps are shown on Pages 16-22.
- The Alternate Programming Method steps are shown on Pages 23-31.

Telephone Audio Prompts

When programming over the telephone, each programming step consists of entering programming data using the telephone's keypad. The system will sound beeps over the telephone to indicate correct or incorrect entries.

The audio prompts that give feedback during programming are different for each programming method. Those differences are shown in the table to the right.

Re-entering a Command After a Mistake

If an incorrect entry, or an incorrect key is pressed during programming, press **[*]** and start the programming step over again.

Exiting Programming Mode

After programming, be sure to exit Programming Mode.

- ◆ **NOTE:** The AE-100 will automatically exit Programming Mode after two minutes of programming inactivity.

- To exit programming when using the Standard Programming Method, press: **[9][9][#]**
- To exit programming when using the Alternate Programming Method, press: **[9][1][#]**

CONNECTING WITH A TELEPHONE

- CALL THE SYSTEM
- SYSTEM ANSWERS ON THIRD RING
- SYSTEM SOUNDS THE CURRENT STATUS:
 - > ONE SHORT BEEP - ALL RELAYS ON
 - > TWO SHORT BEEPS - ALL RELAYS OFF
 - > ONE LONG BEEP - RELAYS MIXED ON & OFF
- ENTER THE UNIT NUMBER (1-4) AND PRESS #
FOR SINGLE-UNIT INSTALLATIONS ENTER 1#
- ENTER THE MASTER PASSWORD
(DEFAULT PASSWORD IS 123456)
- TO USE STANDARD PROGRAMMING PRESS #
 TO USE ALTERNATE PROGRAMMING PRESS STAR
- BEGIN PROGRAMMING, ENTER STEP NUMBER FOLLOWED BY #

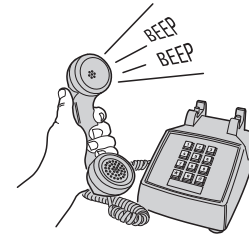
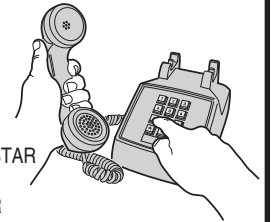
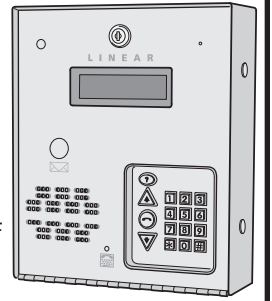

AUDIO PROMPTS FOR EACH PROGRAMMING METHOD

CONDITION	ALTERNATE METHOD SOUND	STANDARD METHOD SOUND
AFTER AN INCORRECT ENTRY	TWO LONG BEEPS	ONE LONG BEEP
AFTER A CORRECT ENTRY OF AN INTERIM STEP	ONE SHORT BEEP	TWO SHORT BEEPS
AFTER A COMPLETE COMMAND HAS BEEN ENTERED CORRECTLY	TWO SHORT BEEPS	THREE SHORT BEEPS
EXITING PROGRAMMING MODE	THREE SHORT BEEPS	NO BEEPS SOUND

TO EXIT PROGRAMMING

▶ **STANDARD PROGRAMMING METHOD** ◀

PRESS **[9][9][#]**

▶ **ALTERNATE PROGRAMMING METHOD** ◀

PRESS **[9][1][#]**

Multi-unit Installations

Up to four AE-100 units may be connected to the same dedicated telephone line to form a simple network. Connecting multiple units allows transferring programming data (either the directory entries only or the entire memory's contents) from the "master" unit to the other sub-units using the system utility commands.

In multi-unit installations each AE-100 must be assigned a unique unit number before programming. The unit number allows connecting to a specific unit when calling for programming and identifies the other units to the master unit. One unit must be assigned as "Master Unit #1".

- ◆ **NOTE:** *If this is the only unit used in the installation, leave the factory setting at one. Skip this programming section.*

These programming steps can only be performed at the AE-100's keypad, they cannot be done remotely via the telephone. For each of the following steps, enter the Master Password and enter Programming Mode (if the unit is not already in that mode).

Setting Unit Numbers

Perform the following steps on **each** AE-100 unit *connected to the same telephone line*.

1. Press: **7 1 #**
2. Enter the unit number (1-4). Make the master unit #1.
3. Press **#**

Setting Sub-unit Numbers in the Master Unit

Perform the following steps on the **master unit**.

1. Press: **0 7 #**
2. Enter the unit numbers of all of the sub-units:
 - In a two unit installation enter **2 #**
 - In a three unit installation enter **2 3 #**
 - In a four unit installation enter **2 3 4 #**
 - To reset to a single-unit installation enter **0 #**
(also be sure to set the unit number back to Unit #1)
- ◆ **NOTE:** *If one of the sub-units goes down for service or is removed from the installation, notify service personnel to reprogram this step on the master unit to remove the missing sub-unit. This will prevent errors when the master unit tries to communicate with the missing sub-unit.*

NOTE:

AFTER SETTING UP A MULTI-UNIT INSTALLATION WITH THESE STEPS, WRITE IN THE UNIT LOCATIONS BELOW AND ON PAGE 6 IN THE FACILITY MANAGER'S GUIDE TO INDICATE TO THE FACILITY MANAGER THE UNIT NUMBERS ASSIGNED AND THEIR LOCATIONS.

UNIT #	UNIT TYPE	UNIT LOCATION
1	MASTER UNIT	
2	SUB-UNIT	
3	SUB-UNIT	
4	SUB-UNIT	

SETTING A UNIT NUMBER

PPN 71

71 #UNIT #

UNIT = UNIT NUMBER (1-4) FOR MULTI-UNIT INSTALLATION

FACTORY SETTING: UNIT NUMBER 1

SETTING SUB-UNIT NUMBERS

PPN 07

07 #SUB-UNITS #

SUB-UNITS = EACH UNIT NUMBER (2-4) USED IN A MULTI-UNIT INSTALLATION

FACTORY SETTING: NONE

Changing the Master Password

Use this programming step to change the six-digit Master Password.

In **multiple-unit installations** each unit *can* have a unique Master Password, but for simplicity and for easier service, it's recommended to use the same Master Password for each unit.

1. If not already in Programming Mode, connect by telephone or use the keypad. Enter the Master Password and access programming.
2. Press: **0 1 #**
3. Enter the new 6-digit Master Password.
4. Press **#**
5. Enter the new 6-digit Master Password again.
6. Press **#**
7. **Write down the new Master Password here and on Page 3 of the Facility Manager's Guide.**

CHANGING THE MASTER PASSWORD

PPN 01

01 #PASS #PASS #

PASS = THE NEW 6-DIGIT MASTER PASSWORD

FACTORY SETTING: 123456

WRITE MASTER PASSWORD HERE

— — — — —

Resident Data Programming

Up to 125 resident Names and Telephone Numbers can be set. Each resident entry is assigned a **Directory Code**. The Directory Code is the number visitors enter to have the system call the resident. Visitors can also contact a resident displayed by pressing the  key.

Use the programming worksheet supplied to organize the resident data prior to entering it into the system.

For each of the following steps, enter the Master Password and enter Programming Mode (if the unit is not already in that mode). Exit Programming Mode when all programming is complete.

Changing the Directory Code Length

The factory setting for the Directory Code length is 3 digits. It can be set to 2 or 3 digits.

1. Press   
2. Enter the **Directory Code** length (2 or 3).
3. Press 

DIRECTORY CODE LENGTH













PPN 02

02#LENGTH#

LENGTH = NUMBER (2-3) OF DIRECTORY CODE DIGITS

FACTORY SETTING: 3 DIGITS

Adding a Directory Entry for a Resident

1. Press   
2. Enter the **Directory Code** that will be displayed for the resident.
3. Press 
- ◆ **NOTE:** To add the name using all capital letters, press  before entering the name.
4. Enter the **Name** of the resident to be displayed (up to 16 characters).
5. Press 
6. Enter the resident's **Telephone Number** (up to 14 digits). Press and hold down the , , , or  key to enter 1-4 two-second pauses. Hold down the key for about two seconds. Note: Each pause entered counts as one of the 14 digits allowed in the telephone number.
7. Press 
8. Enter a unique four-digit **Entry Code** for this resident.
9. Press 
10. Enter the four-digit **Entry Code** again for verification.
11. Press 

ADDING A DIRECTORY ENTRY FOR A RESIDENT

PPN 21

21#DIR#NAME#PHONE#CODE#CODE#

DIR = DIRECTORY CODE FOR THE RESIDENT

NAME = THE RESIDENT'S NAME (UP TO 16 CHARACTERS)











PHONE = THE RESIDENT'S TELEPHONE NUMBER (UP TO 14 DIGITS)

CODE = ENTRY CODE FOR THIS RESIDENT (4 DIGITS)

CODE = ENTRY CODE ENTERED AGAIN FOR VERIFICATION

Modifying an Existing Directory Entry

Once a Directory Entry has been set, it can be modified to change a resident's Name, Telephone Number, or Entry Code.

- ◆ **NOTE:** This step cannot be performed remotely through the telephone.
1. Press   
 2. Enter the resident's **Directory Code**.
 3. Press 
 - ◆ **NOTE:** To modify the name using all capital letters, press  before entering the name.
 4. Modify the **Name** of the resident to be displayed (up to 16 characters) and press , or to keep the same name just press .
 5. Modify the resident's **Telephone Number** (up to 14 digits, see how to enter pauses above) and press , or to keep the same Telephone Number just press .
 6. Modify the resident's four-digit **Entry Code** and press , or to keep the same Entry Code just press .

MODIFYING AN EXISTING DIRECTORY ENTRY

PPN 22

22#DIR#NAME#PHONE#CODE#

DIR = DIRECTORY CODE FOR THE RESIDENT





NAME = THE RESIDENT'S NAME (UP TO 16 CHARACTERS)

PHONE = THE RESIDENT'S TELEPHONE NUMBER (UP TO 14 DIGITS)

CODE = THE RESIDENT'S ENTRY CODE (4 DIGITS)

Deleting an Existing Directory Entry

Directory Entries can be deleted individually (to delete all Directory Entries, see programming Step 92).

1. Press   
2. Enter the Directory Code.
3. Press 
4. Enter the Directory Code again.
5. Press 

DELETING AN EXISTING DIRECTORY ENTRY

PPN 23

23#DIR#DIR#

DIR = DIRECTORY CODE FOR THE RESIDENT

DIR = DIRECTORY CODE ENTERED AGAIN FOR VERIFICATION

Stand-alone Entry Code Programming

A **Stand-alone Entry Code** is a number entered at the AE-100 keypad to request access. Up to 125 4-digit Stand-alone Entry Codes can be set.



- ◆ **NOTE:** Each Stand-alone Entry Code programmed reduces the possible number of Directory Entries by one.

Use the programming worksheet supplied to organize the Stand-alone Entry Code data prior to entering it into the system.

For each of the following steps, enter the Master Password and enter Programming Mode (if the unit is not already in that mode). Exit Programming Mode when all programming is complete.

Adding a Stand-alone Entry Code

Stand-alone Entry Codes are entered individually.

1. Press **3 1** 
2. Enter the new **Stand-alone Entry Code**.
3. Press 
4. Enter the new **Stand-alone Entry Code** again for verification.
5. Press 

ADDING A STAND-ALONE ENTRY CODE



PPN 31

31 #CODE#CODE#

CODE = NEW STAND-ALONE ENTRY CODE
CODE = NEW STAND-ALONE ENTRY CODE
AGAIN FOR VERIFICATION

Deleting a Stand-alone Entry Code

Stand-alone Entry Codes can be deleted individually (to delete all Stand-alone Entry Codes, see programming Step 93).

1. Press **3 3** 
2. Enter the **Stand-alone Entry Code** to delete.
3. Press 
4. Enter the **Stand-alone Entry Code** to delete again.
5. Press 

DELETING A STAND-ALONE ENTRY CODE

PPN 33

33 #CODE#CODE#

CODE = THE STAND-ALONE ENTRY CODE TO DELETE
CODE = THE STAND-ALONE ENTRY CODE
AGAIN FOR VERIFICATION

System Options

For most installations the factory settings for the system will be appropriate. To customize the system, enter programming mode via telephone or keypad.

Use the programming worksheet supplied to log any system option changes prior to entering it into the system.



For each of the following steps, enter the Master Password and enter Programming Mode (if the unit is not already in that mode). Exit Programming Mode when all programming is complete.

System Display Language

The factory default language is English. Three other languages can be selected as the language for the user and programming displays.

- ◆ **NOTE:** This step cannot be performed remotely through the telephone.

- ◆ **NOTE:** The system supports one display language at a time.

1. Press **3 8** 
2. Choose a language:
 - Enter 1 for English
 - Enter 2 for Spanish
 - Enter 3 for French
 - Enter 4 for Portuguese
3. Press 

SYSTEM DISPLAY LANGUAGE

PPN 38

38 #LANG#

LANG = SYSTEM DISPLAY LANGUAGE
1 = ENGLISH 2 = SPANISH
3 = FRENCH 4 = PORTUGUESE

FACTORY SETTING: ENGLISH

System Options (Continued)

Keypad Lockout Count

The system counts the number of invalid Entry Codes entered at the keypad. If the invalid entries exceeds the lockout count number, the keypad is locked out for 90 seconds. The factory setting for the lockout count is three. The lockout value can be from one to nine.

1. Press **5 1** **⏏**
2. Enter the number for the lockout count (1-9).
3. Press **⏏**

KEYPAD LOCKOUT COUNT

PPN 51

51 #COUNT

COUNT = NUMBER (1-9) OF INCORRECT ENTRIES
THAT WILL CAUSE A 90 SECOND LOCKOUT

FACTORY SETTING: 3 TRIES

Access Relay Activation Time

The factory setting will cause the access relay to activate for 4 seconds. The activation time can be set from 4-99 seconds to accommodate different types of access control devices.

1. Press **5 2** **⏏**
2. Enter the time (in seconds) for access relay to stay activated (04-99)
3. Press **⏏**

ACCESS RELAY ACTIVATION TIME

PPN 52

52 #SECONDS

SECONDS = ACTIVATION TIME (04-99 SECONDS)

FACTORY SETTING: 4 SECONDS

Welcome Display Text

The AE-100 display will show a visitor a welcome message alternating with instructions on how to find and call a resident. The welcome message can be customized to suit the installation.

- ◆ **NOTE:** This step cannot be performed remotely through the telephone.
1. Press **5 7** **⏏**
 - ◆ **NOTE:** To enter capital letters only, press **⏏** first before entering the text.
 2. Enter the new text for the top line of the display (up to 16 characters).
 3. Press **⏏**
 - ◆ **NOTE:** To enter capital letters only, press **⏏** first before entering the text.
 4. Enter the new text for the bottom line of the display (up to 16 characters).
 5. Press **⏏**

WELCOME DISPLAY TEXT

PPN 57

57 #LINE 1 #LINE 2

LINE 1 = UP TO 16 CHARACTERS TEXT
LINE 2 = UP TO 16 CHARACTERS TEXT

FACTORY SETTING: LINEAR ACCESS TELEPHONE ENTRY

Automatic Telephone Answer

The factory setting will allow the system to detect a ring signal on the telephone line and answer the call.

- ◆ **NOTE:** The automatic answer feature can be turned off, although remote programming, remote access control by residents, and resident call-back features will no longer function.
1. Press **6 1** **⏏**
 2. Select the option for automatic telephone answering:
 - Enter 0 to turn OFF automatic telephone answering.
 - Enter 1 to turn ON automatic telephone answering.
 3. Press **⏏**

AUTOMATIC TELEPHONE ANSWER

PPN 61

61 #ANSWER

ANSWER = 0 FOR AUTO ANSWER OFF
ANSWER = 1 FOR AUTO ANSWER ON

FACTORY SETTING: AUTO ANSWER ON

Speaker Chirp on Keystrokes

The factory setting will cause the speaker to chirp when each key on the keypad is pressed. Alternately, the speaker chirp can be turned off.

1. Press **6 2** **⏏**
2. Select the option for keystroke speaker chirps:
 - Enter 0 to turn OFF the keystroke speaker chirps.
 - Enter 1 to turn ON the keystroke speaker chirps.
3. Press **⏏**

SPEAKER CHIRP ON KEYSTROKE

PPN 62

62 #CHIRP

CHIRP = 0 FOR KEYSTROKE CHIRP OFF
CHIRP = 1 FOR KEYSTROKE CHIRP ON

FACTORY SETTING: KEYSTROKE CHIRP ON

System Options (Continued)

Speaker Tone on Access Relay Activation

The factory setting will cause the speaker to sound a tone for two seconds when the access relay is activated. Alternately, the tone can be turned off.

1. Press **6 3 #**
2. Select the option for access relay activation tone:
 - Enter 0 to turn OFF the access relay activation tone.
 - Enter 1 to turn ON the access relay activation tone.
3. Press **#**

SPEAKER TONE ON ACCESS RELAY ACTIVATION

PPN 63

63#TONE#

TONE = 0 FOR ACCESS RELAY TONE OFF
TONE = 1 FOR ACCESS RELAY TONE ON

FACTORY SETTING: RELAY TONE ON

Maximum Visitor Talk Time

Visitors will converse with residents over the telephone until the resident grants or denies access. If the resident responds to the visitor's request by pressing their telephone key, the system will hang up and release the telephone line. If for some reason the resident does not press the telephone key or does not hang up, the system will automatically disconnect the visitor after 60 seconds.

At ten and five seconds before the disconnect, a tone will sound on the telephone to remind the resident of the pending disconnect. The resident can extend the talk time by pressing the # key on their telephone. The disconnect time can be adjusted from 10-180 seconds.

1. Press **6 4 #**
2. Enter the disconnect time in seconds (010-180):
3. Press **#**

MAXIMUM VISITOR TALK TIME

PPN 64

64#TIME#

TIME = TIME UNTIL AUTO-DISCONNECT
(010-180 SECONDS)

FACTORY SETTING: 60 SECONDS

Resident Control of Access Relay

The factory setting allows the resident to activate the access relay by pressing the 9 key on their telephone when a call from the AE-100 is received. This feature can be disabled. Disabling this feature will only allow access by using resident Entry Codes and Stand-alone Entry Codes at the unit's keypad.

1. Press **7 7 #**
2. Select the option for resident access relay control:
 - Enter 0 to turn OFF resident access relay control.
 - Enter 1 to turn ON resident access relay control.
3. Press **#**

RESIDENT CONTROL OF ACCESS RELAY

PPN 77

77#CONTROL#

CONTROL = 0 TO DISABLE RESIDENT CONTROL
CONTROL = 1 TO ENABLE RESIDENT CONTROL

FACTORY SETTING: RESIDENT CONTROL ENABLED

Resident Call-back

The resident call-back feature allows the AE-100 to answer the telephone and switch to speakerphone mode if the telephone call is within 60 seconds of the last use of the AE-100. This feature gives residents the capability to call a visitor back in case of a recently missed call.

This feature can only be used in single unit installations.

The factory setting disables the resident call-back feature. Alternately, this feature can be enabled.

◆ **NOTE:** The Automatic Telephone Answer feature (PPN #61) must also be enabled for the resident call-back feature to function.

1. Press **9 5 #**
2. Select the option for resident call-back:
 - Enter 0 to turn OFF the resident call-back feature.
 - Enter 1 to turn ON the resident call-back feature.
3. Press **#**

RESIDENT CALL-BACK

PPN 95

95#CALL-BACK#

CALL-BACK = 0 TO DISABLE RESIDENT CALL-BACK
CALL-BACK = 1 TO ENABLE RESIDENT CALL-BACK

FACTORY SETTING: RESIDENT CALL-BACK DISABLED

System Utility Commands

Several utility commands are available for the system. Utility commands can be used to copy data to other units in a multi-unit installation, clear memory, display system information, and control the relays.

For each of the following steps, enter the Master Password and enter Programming Mode (if the unit is not already in that mode). Exit Programming Mode when all programming is complete.

Copy Access Data Only from Master to Sub-units

To synchronize programming in multi-unit installations, the Directory Entries and Stand-alone Entry Codes can be copied from the master unit to selected sub-units.

◆ **NOTE:** PPN numbers 71 and 7 must be programmed before this command will operate.

◆ **NOTE:** This utility command can only be performed from the "master" unit.

⚠ **CAUTION:** This utility command will overwrite **ALL the access data** in the selected sub-units.

- Press **3 0 #**
- Enter the unit number(s) of all of the sub-units to receive the access data.
Examples:
 - To copy to unit two only enter **2 #**
 - To copy to unit three only enter **3 #**
 - To copy to units two & three enter **2 3 #**
 - To copy to units two, three, and four enter **2 3 4 #**
- To execute the command, enter **5 #** or enter ***** to exit (any other entry will abort the command).

COPY ACCESS DATA ONLY FROM MASTER TO SUB-UNITS PPN 30

30#SUB-UNITS#5#

SUB-UNITS = EACH SUB-UNIT NUMBER (2-4) TO COPY ACCESS DATA TO IN A MULTI-UNIT INSTALLATION

NOTE:

TO ALLOW FOR MULTI-UNIT NETWORK COMMUNICATIONS, WHEN EXECUTING THIS COMMAND REMOTELY OVER THE TELEPHONE, THE SYSTEM WILL DISCONNECT YOUR CALL AFTER STEP #3 THEN COPY THE DATA FROM THE MASTER UNIT TO THE SUB-UNITS.

Copy All Data from Master to Sub-units

To synchronize programming in multi-unit installations, all system data can be copied from the master unit to selected sub-units. This data includes the Directory Entries, Stand-alone Entry Code data, and all system option settings (except the sub-unit number and password).

◆ **NOTE:** PPN numbers 71 and 7 must be programmed before this command will operate.

◆ **NOTE:** This utility command can only be performed from the "master" unit.

⚠ **CAUTION:** This utility command will overwrite **ALL the data** in the selected sub-units.

- Press **3 4 #**
- Enter the unit number(s) of all of the sub-units to receive the full data set.
Examples:
 - To copy to unit two only enter **2 #**
 - To copy to unit three only enter **3 #**
 - To copy to units two & three enter **2 3 #**
 - To copy to units two, three, and four enter **2 3 4 #**
- To execute the command, enter **5 #** or enter ***** to exit (any other entry will abort the command).

COPY ALL DATA FROM MASTER TO SUB-UNITS PPN 34

34#SUB-UNITS#5#

SUB-UNITS = EACH SUB-UNIT NUMBER (2-4) TO COPY ALL DATA TO IN A MULTI-UNIT INSTALLATION

NOTE:

TO ALLOW FOR MULTI-UNIT NETWORK COMMUNICATIONS, WHEN EXECUTING THIS COMMAND REMOTELY OVER THE TELEPHONE, THE SYSTEM WILL DISCONNECT YOUR CALL AFTER STEP #3 THEN COPY THE DATA FROM THE MASTER UNIT TO THE SUB-UNITS.

Display/Clear System Errors

The system's power indicator will flash if any system errors occur. These errors include loss of AC power and low backup battery. In multi-unit installations, the master unit logs communication errors with sub-units.

◆ **NOTE:** This step cannot be performed remotely through the telephone.

- Press **3 5 #**
- The display will show any errors pending.
- Press **#** to display the next error message (if any).
- When there are no more error messages to be displayed, the system will display "Clear Error Log?".
- Enter **5 #** to clear the error log - or - enter **#** to exit.

DISPLAY/CLEAR SYSTEM ERRORS PPN 35

35#MESSAGE#CLEAR#

MESSAGE = ERROR MESSAGE DISPLAYED
CLEAR = 5 TO CLEAR ERROR LOG
CLEAR = # TO EXIT WITHOUT CLEARING ERROR LOG

System Utility Commands (Continued)

Poll Sub-units

In multi-unit installations, this utility command will instruct the master unit to poll the sub-units (request and receive communications). This command is used for testing purposes only.

1. Press **3 7** \square
2. The display will show the unit numbers that responded on the first try error free.
3. Enter another programming step number followed by \square or press \star to exit.

POLL SUB-UNITS

PPN 37

37#POLL RESULT

POLL RESULT = DISPLAY OF SUB-UNIT NUMBERS THAT RESPONDED WITH NO ERRORS ON THE FIRST TRY

Display System Information

The version of the firmware installed in the AE-100 can be displayed.

◆ **NOTE:** This step cannot be performed remotely through the telephone.

1. Press **7 3** \square
2. The display will show the firmware version.
3. Press \square to exit.

DISPLAY SYSTEM INFORMATION

PPN 73

73#INFO

INFO = DISPLAY OF SYSTEM FIRMWARE VERSION

Timed Access Relay Latch

For servicing or testing, while in Programming Mode, the access relay can be latched manually from the keypad for a period of hours.

1. Press **8 0** \square
2. Enter the amount of time in hours (01-98) for the access relay to latch.
3. Press \square

TIMED ACCESS RELAY LATCH

PPN 80

80#HOURS#

HOURS = RELAY LATCH TIME IN HOURS (01-98)

Latch Access Relay

For servicing or testing, while in Programming Mode, the access relay can be latched manually from the keypad for an indefinite period of time.

◆ **NOTE:** This command will reset and override and timed access relay latch set by PPN 80.

1. Press **8 1** \square

LATCH ACCESS RELAY

PPN 81

81#

Release Access Relay

For servicing or testing, while in Programming Mode, this command will release the access relay if it has been manually latched (timed or indefinite).

1. Press **8 3** \square

RELEASE ACCESS RELAY

PPN 83

83#

Delete All Directory Entries

This utility command will **permanently** erase all Directory Codes, Names, Telephone Numbers, and resident's Entry Codes.

⚠ **CAUTION:** This utility command will erase **all the Directory Entries** in the unit.

◆ **NOTE:** This step cannot be performed remotely through the telephone.

1. Press **9 2** \square
2. Press **9 2** \square again for verification.

DELETE ALL DIRECTORY ENTRIES

PPN 92

92#92#

Delete All Stand-alone Entry Codes

This utility command will **permanently** erase all Stand-alone Entry Codes.

⚠ **CAUTION:** This utility command will erase **ALL the Stand-alone Entry Codes** in the unit.

◆ **NOTE:** This step cannot be performed remotely through the telephone.

1. Press **9 3** \square
2. Press **9 3** \square again for verification.

DELETE ALL STAND-ALONE ENTRY CODES

PPN 93

93#93#

Total Memory Reset

This command will erase all data and restore the factory settings.

⚠ **CAUTION:** This utility command will erase **ALL the data** in the unit.

◆ **NOTE:** This step cannot be performed remotely through the telephone.

1. Press: **2 0 0** \square
2. Press: **0 0 0 0 0 0** \square
3. Press: **0 0 0 0 0 0** \square again for verification.

TOTAL MEMORY RESET

PPN 200

200#000000#000000#

Alternate Programming Section

To make it easy for installers familiar with Linear's and other manufacturer's access control systems, two methods of programming are available. Function Codes that match other equipment help the installer to make quick programming changes with keystrokes they have used before.

Alternate Programming Method Selection

The Programming Position Numbers (or Function Codes) change depending on the programming method used. Refer to the table on Page 13 for the numbers used for each programming method.

The keys used to enter programming from the unit's keypad select which programming method is used for the current programming session.

Entering programming by pressing **0** & **#** keys together will select the Alternate Programming Method (other manufacturer's style). **Details of each programming step when using the Alternate Programming Method are shown on Pages 23-31.**

Alternate Audio Prompts

The audio prompts that give feedback during programming at the unit's keypad or over the telephone are different for the Alternate Programming Method. Those differences are shown in the table to the right.

Alternate Alphanumeric Entry

When the keypad is used for alphanumeric data entry in the alternate programming mode, each key enters data differently than the standard interface mode. See the keypad figure to the right.

Alternate Programming Access from the Keypad

1. Press **0** & **#** keys at the same time, then release.
2. The display will show **[Master Code:]**.
3. Enter the master code (factory setting is 123456).
4. The display will show asterisks as the code is entered.
5. If the master code is incorrect, the system will sound two long beeps and return to normal operating mode.
6. If the password is correct, the display will show **[SELECT FUNCTION:]**.
7. Programming commands can now be entered on the keypad. Refer to the following pages in this manual for Alternate Programming Method step details.

Re-entering a Command After a Mistake

If an incorrect entry, or an incorrect key is pressed during programming, to clear the keypad press ***** and start the programming step over again.

Exiting Alternate Programming Mode

1. Press: **9 1 #**
- ◆ **NOTE:** The AE-100 will automatically exit Programming Mode after five minutes of programming inactivity.

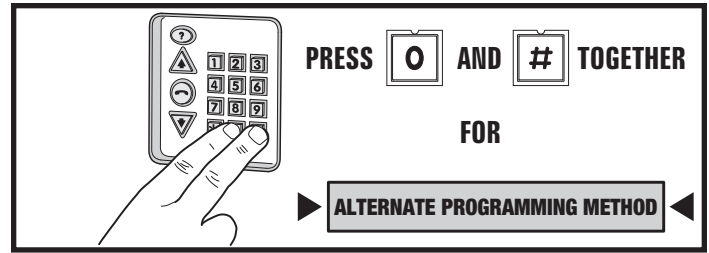

AUDIO PROMPTS FOR EACH PROGRAMMING METHOD		
CONDITION	ALTERNATE METHOD SOUND	STANDARD METHOD SOUND
AFTER AN INCORRECT ENTRY	TWO LONG BEEPS	ONE LONG BEEP
AFTER A CORRECT ENTRY OF AN INTERIM STEP	ONE SHORT BEEP	TWO SHORT BEEPS
AFTER A COMPLETE COMMAND HAS BEEN ENTERED CORRECTLY	TWO SHORT BEEPS	THREE SHORT BEEPS
EXITING PROGRAMMING MODE	THREE SHORT BEEPS	NO BEEPS SOUND

**ALTERNATE INTERFACE KEYPAD ALPHANUMERIC ENTRY
(FOR PROGRAMMING STEPS REQUIRING TEXT)**

Q Z - , . ' *	A B C a b c	D E F d e f
q z 0 1 2 3	1 2 3	
4 5 6 7 8 9	4 5 6	
J K L j k l	7 8 9	
G H I h g i	* 0 #	M N O m n o
T U V t u v		W X Y w x y
P R S p r s	space	
erase entire entry		move to next letter or finish

- ENTER # AFTER EACH LETTER TO MOVE TO THE NEXT CHARACTER
- FINISH COMPLETE ENTRY BY ENTERING ##
- PRESS 8 THEN 0 TO BACKSPACE
- PRESS STAR TO ERASE ENTIRE ENTRY

Alternate Programming Reference

Refer to the following pages when programming using the Alternate Programming method.

For each of the following steps, enter the Master Password and enter Programming Mode (if the unit is not already in that mode). Exit Programming Mode when all programming is complete.

FUNCTION CODE	LOCAL PROGRAMMING	TELEPHONE PROGRAMMING
<p style="text-align: center;">00</p> <p style="text-align: center;">REPLACE SYSTEM MASTER CODE</p> <p>(Default Setting is 123456)</p> <p>Master Code is used to log into programming mode, not to unlock door or gate.</p>	<p>Step 1 Enter Function Code 00, then press #</p> <div style="border: 1px solid black; padding: 2px; width: fit-content; margin: 5px auto;">MASTER CODE:</div> <p>Step 2 Enter the new 6-digit Master Code</p> <p>Step 3 Press #</p>	<p>Step 1 Enter Function Code 00 and press #, one short beep sounds.</p> <p>Step 2 Enter the new Master Code.</p> <p>Step 3 Press #, two short beeps sound.</p>
<p style="text-align: center;">01</p> <p style="text-align: center;">PROGRAM A NEW TENANT</p> <p>There are four different fields that need to be programmed: Directory Code, Name, Telephone Number, and Access Code.</p> <p>Directory Code: A unique 2 or 3 digit code assigned to each tenant for identification.</p> <p>Name: Up to 16 characters.</p> <p>Telephone Number: Up to 14 digits.</p> <p>Access Code: 4-digit code assigned to tenant for obtaining access with the keypad.</p> <p>NOTES:</p> <ol style="list-style-type: none"> 1. Directory Codes can be set for 2 or 3 digits. All Directory Codes will be the same length. 2. A Directory Code cannot be duplicated. 3. Each Directory Code represents one tenant. 4. Delete unused Directory Codes to avoid running out of memory. 5. Tenant Names can be entered in any order. The system will display the Names in alphabetical order. 6. The same Name, Telephone Number, and Access Code can exist with different Directory Codes. 	<p>Step 1 Enter Function Code 01, then press #.</p> <div style="border: 1px solid black; padding: 2px; width: fit-content; margin: 5px auto;">ENTER DIR:</div> <p>Step 2 Enter the new 2 or 3 digit Directory Code.</p> <div style="border: 1px solid black; padding: 2px; width: fit-content; margin: 5px auto;">ENTER NAME:</div> <p>Proceed to Step 3.</p> <p>If the Directory Code has already been used the display shows:</p> <div style="border: 1px solid black; padding: 2px; width: fit-content; margin: 5px auto;">DIR # IS USED!</div> <p>Return to Step 2.</p> <p>If the memory is full the display shows:</p> <div style="border: 1px solid black; padding: 2px; width: fit-content; margin: 5px auto;">ERROR DATA</div> <p>Return to Step 2.</p> <p>Step 3 Enter the tenant Name (up to 16 characters), press # after each character, then # again after the last character.</p> <div style="border: 1px solid black; padding: 2px; width: fit-content; margin: 5px auto;">TELEPHONE #:</div> <p>Step 4 Enter the tenant's Telephone Number (up to 14 digits), press # after each number, then # again after the last number. Press and hold down the 1, 2, 3, or 4 key for about two seconds to enter 1-4 two second pauses. Note: Each pause entered counts as one of the 14 digits.</p> <div style="border: 1px solid black; padding: 2px; width: fit-content; margin: 5px auto;">ACCESS CODE:</div> <p>Step 5 Enter the 4-digit Access Code,</p> <p>Step 6 Press #.</p>	<p>Step 1 Enter Function Code 01 and press #, one short beep sounds.</p> <p>Step 2 Enter the new Directory Code (2 or 3 digits) and press #, one short beep sounds. (If you hear two long beeps, the Directory Number already exists, return to Step 1.)</p> <p>Step 3 Enter the Name (up to 16 characters) press # after each character, then # again after the last character, one short beep sounds.</p> <p>Step 4 Enter Telephone Number (up to 14 digits), press # after each number, then # again after the last number and press #, one short beep sounds.</p> <p>Step 5 Enter the 4-digit Access Code, then press #, two short beeps sound.</p>

FUNCTION CODE	LOCAL PROGRAMMING	TELEPHONE PROGRAMMING
<p style="text-align: center; font-size: 24pt; font-weight: bold;">02</p> <p style="text-align: center; font-weight: bold;">MODIFY AN EXISTING TENANT DIRECTORY ENTRY</p> <p>Choose a tenant's Directory Code to modify (you must know the tenant's Directory Code to modify).</p>	<p>Step 1 Enter Function Code 02, then press #.</p> <div style="border: 1px solid black; padding: 2px; text-align: center; margin: 5px 0;">MODIFY DIR:</div> <p>Step 2 Enter the new 2 or 3 digit Directory Code.</p> <div style="border: 1px solid black; padding: 2px; text-align: center; margin: 5px 0;">ENTER THE NAME:</div> <p>Then the tenant's current Name is displayed:</p> <div style="border: 1px solid black; padding: 2px; text-align: center; margin: 5px 0;"><CURRENT NAME></div> <p>Step 3 To keep the Name press # and skip to Step 5.</p> <p>Step 4 To change the Name press * then enter a new Name (up to 16 characters), press # after each character, then # again after the last character:</p> <div style="border: 1px solid black; padding: 2px; text-align: center; margin: 5px 0;">PHONE NUMBER <CURRENT PH#></div> <p>Step 5 To keep the Telephone Number press # and skip to Step 7.</p> <p>Step 6 To change the Telephone Number press * then enter a new Telephone Number (up to 14 digits), press # after each number, then # again after the last number. Press and hold down the 1, 2, 3, or 4 key for about two seconds to enter 1-4 two-second pauses. Note: each pause entered counts as one of the 14 digits allowed in the telephone number.</p> <div style="border: 1px solid black; padding: 2px; text-align: center; margin: 5px 0;">ACCESS CODE: <CURRENT CODE></div> <p>Step 7 To keep the Access Code press #.</p> <p>Step 8 To change the Access Code, enter a new 4-digit Access Code, then press #.</p>	<p style="font-weight: bold; font-size: 18pt;">NOT AVAILABLE</p>
<p style="text-align: center; font-size: 24pt; font-weight: bold;">03</p> <p style="text-align: center; font-weight: bold;">DELETE AN EXISTING TENANT DIRECTORY ENTRY</p> <p>Deletes a single existing Directory Entry. This command frees up memory occupied by an unused Directory Entry.</p>	<p>Step 1 Enter Function Code 03, then press #.</p> <div style="border: 1px solid black; padding: 2px; text-align: center; margin: 5px 0;">DELETE DIR:</div> <p>Step 2 Enter the 2 or 3 digit Directory Code to delete, then press #:</p> <div style="border: 1px solid black; padding: 2px; text-align: center; margin: 5px 0;"><DIR CODE> IS DELETED !</div> <p>If the Directory Code does not exist, the display will show an error, return to Step #1.</p> <div style="border: 1px solid black; padding: 2px; text-align: center; margin: 5px 0;">ERROR ON DELETE</div>	<p>Step 1 Enter Function Code 03 and press #, one short beep sounds.</p> <p>Step 2 Enter the Directory Code (2 or 3 digits) to delete and press #, two short beeps sound. (If you hear one long beep followed by two short beeps, the Directory Code did not exist, return to Step 1.)</p>
<p style="text-align: center; font-size: 24pt; font-weight: bold;">04</p> <p style="text-align: center; font-weight: bold;">CLEAR ALL TENANT DIRECTORY ENTRIES</p> <p>Deletes all existing Directory Entries. This command will erase all Directory Codes, Names, Telephone Numbers and directory-linked Access Codes.</p> <p>⚠ CAUTION: This utility command will erase ALL the Directory Entries in the unit.</p>	<p>Step 1 Enter Function Code 04, then press #.</p> <div style="border: 1px solid black; padding: 2px; text-align: center; margin: 5px 0;">DELETE ALL? 13</div> <p>Step 2 Enter the number displayed, then press #:</p> <div style="border: 1px solid black; padding: 2px; text-align: center; margin: 5px 0;">ARE YOU SURE? 5</div> <p>Step 3 Enter 5 for verification, then press # (or press * to cancel).</p>	<p style="font-weight: bold; font-size: 18pt;">NOT AVAILABLE</p>

FUNCTION CODE	LOCAL PROGRAMMING	TELEPHONE PROGRAMMING															
<p style="text-align: center;">05</p> <p>MANUAL ACCESS RELAY CONTROL</p> <p>This command can be used to latch the access relay indefinitely or for a period of time, and to unlatch the access relay.</p>	<p>Step 1 Enter Function Code 05, then press #.</p> <div style="border: 1px solid black; padding: 2px; text-align: center; margin: 5px 0;">OPEN:00 HOURS</div> <p>Step 2 Enter the number of hours from 01-98 to energize the access relay, then press #.</p> <p>- OR -</p> <p>Enter the 99 to energize the access relay indefinitely, then press #.</p> <p>- OR -</p> <p>Enter the 00 to de-energize the access relay, then press #.</p> <p>- OR -</p> <p>Enter * to cancel this command.</p>	<p>Step 1 Enter Function Code 05 and press #, one short beep sounds.</p> <p>Step 2 Enter the number of hours from 01-98 to energize the access relay, then press #.</p> <p>- OR -</p> <p>Enter the 99 to energize the access relay indefinitely, then press #.</p> <p>- OR -</p> <p>Enter the 00 to de-energize the access relay, then press #.</p> <p>Two long beeps and two short beeps will sound.</p>															
<p style="text-align: center;">06</p> <p>DIRECTORY CODE LENGTH</p> <p>Selects 2 or 3 digits for the Directory Code length (factory default is 3 digits).</p> <p>NOTE: In multi-unit installations, if sub-units are being updated with access data that has Directory Codes with more digits than the sub-unit is set for, the sub-unit's Directory Code length number will be automatically adjusted to fit.</p>	<p>Step 1 Enter Function Code 06, then press #.</p> <div style="border: 1px solid black; padding: 2px; text-align: center; margin: 5px 0;">DIR DIGITS: 3</div> <p>Step 2 The display shows the current value. Enter 2 or 3, then press #.</p> <p>- OR -</p> <p>Enter * to cancel this command.</p>	<p>NOT AVAILABLE</p>															
<p style="text-align: center;">07</p> <p>SET SUB-UNIT NUMBERS IN MASTER</p> <p>Sets the master's sub-unit numbers in multi-unit installations.</p> <p>NOTES:</p> <ol style="list-style-type: none"> 1. This command is for the master unit in a multi-unit installation only. 2. If one of the sub-units goes down for service or is removed, notify service personnel to reprogram this step on the master unit to remove the missing sub-unit. This will prevent errors when the master unit tries to communicate with the missing sub-unit. 	<p>Step 1 Enter Function Code 07, then press #.</p> <div style="border: 1px solid black; padding: 2px; text-align: center; margin: 5px 0;"># SUB-UNITS(2-4)</div> <p>Step 2 Enter the unit numbers of all sub-units (2, 3, & 4) To reset to a single-unit installation, enter 0 (also be sure to set the unit number back to Unit #1)</p> <p>Step 3 Press #.</p>	<p style="text-align: center;">NOT AVAILABLE</p> <p style="text-align: center;">NOTE:</p> <p>AFTER SETTING UP A MULTI-UNIT INSTALLATION WITH FUNCTIONS 07 & 08, WRITE IN THE UNIT LOCATIONS BELOW AND ON PAGE 6 IN THE FACILITY MANAGER'S GUIDE TO INDICATE TO THE FACILITY MANAGER THE UNIT NUMBERS ASSIGNED AND THEIR LOCATIONS.</p> <table border="1" style="width: 100%; border-collapse: collapse; margin-top: 10px;"> <thead> <tr> <th style="width: 10%;">UNIT #</th> <th style="width: 40%;">UNIT TYPE</th> <th style="width: 50%;">UNIT LOCATION</th> </tr> </thead> <tbody> <tr> <td style="text-align: center;">1</td> <td style="text-align: center;">MASTER UNIT</td> <td></td> </tr> <tr> <td style="text-align: center;">2</td> <td style="text-align: center;">SUB-UNIT</td> <td></td> </tr> <tr> <td style="text-align: center;">3</td> <td style="text-align: center;">SUB-UNIT</td> <td></td> </tr> <tr> <td style="text-align: center;">4</td> <td style="text-align: center;">SUB-UNIT</td> <td></td> </tr> </tbody> </table>	UNIT #	UNIT TYPE	UNIT LOCATION	1	MASTER UNIT		2	SUB-UNIT		3	SUB-UNIT		4	SUB-UNIT	
UNIT #	UNIT TYPE	UNIT LOCATION															
1	MASTER UNIT																
2	SUB-UNIT																
3	SUB-UNIT																
4	SUB-UNIT																
<p style="text-align: center;">08</p> <p>ASSIGN UNIT NUMBER</p> <p>Sets the sub-unit's number in multi-unit installations.</p> <p>NOTE 1: This command is for multi-unit installations only.</p> <p>NOTE 2: The master unit in a multi-unit installation must be #1. All systems must have one unit set to #1.</p>	<p>Step 1 Enter Function Code 08, then press #.</p> <div style="border: 1px solid black; padding: 2px; text-align: center; margin: 5px 0;">SYSTEM # (1-4) 1</div> <p>Step 2 The display shows the current value. Enter the unit number of this sub-unit (2, 3, & 4)</p> <p>Step 3 Press #.</p>	<p>NOT AVAILABLE</p>															

FUNCTION CODE	LOCAL PROGRAMMING	TELEPHONE PROGRAMMING
<p style="text-align: center;">10</p> <p style="text-align: center;">WELCOME DISPLAY TEXT</p> <p>The AE-100 display will show a visitor a welcome message alternating with instructions on how to find and call a resident. The welcome message can be customized to suit the installation.</p>	<p>Step 1 Enter Function Code 10, then press #.</p> <div style="border: 1px solid black; padding: 2px; text-align: center;">(BLANK DISPLAY)</div> <p>Step 2 Enter the new welcome message. A total of 32 characters are allowed. The display will advance to the lower line after the 16th character is entered on the upper line. Enter # after each character, enter ## after the last character.</p>	<p>NOT AVAILABLE</p>
<p style="text-align: center;">30</p> <p style="text-align: center;">COPY ACCESS DATA ONLY FROM MASTER TO SUB-UNITS</p> <p>To synchronize programming in multi-unit installations, the Directory Entries and Stand-alone Entry Codes can be copied from the master unit to selected sub-units.</p> <p>CAUTION: This utility command will overwrite ALL the access data in the sub-unit(s) selected.</p>	<p>Step 1 Enter Function Code 30, then press #.</p> <div style="border: 1px solid black; padding: 2px; text-align: center;">UNITS:</div> <p>Step 2 Enter the number(s) (2, 3, and/or 4) of all the sub-units to copy the data to, then press #.</p> <div style="border: 1px solid black; padding: 2px; text-align: center;">ARE YOU SURE ? 5</div> <p>Step 3 Enter 5 for verification, then press #.</p> <p style="text-align: center;">- OR -</p> <p>Enter * to cancel this command.</p> <p>NOTE: Function Codes 7 and 8 must be programmed before this command will operate.</p>	<p>Step 1 Enter Function Code 30 and press #, one short beep sounds.</p> <p>Step 2 Enter the number(s) (2, 3, and/or 4) of all the sub-units to copy the data to, then press #, one short beep sounds.</p> <p>Step 3 Enter 5 for verification, then press #, two short beeps sound. (Any entry other than 5# will cancel the command.)</p> <p>NOTE: To allow for multi-unit network communications, when executing this command remotely over the telephone, the system will disconnect your call after Step #3 then copy the data from the master unit to the sub-units.</p>
<p style="text-align: center;">31</p> <p style="text-align: center;">ADD A STAND-ALONE ACCESS CODE</p> <p>A Stand-alone Access Code is a number entered at the AE-100 keypad to request access. Up to 125 4-digit Stand-alone Access Codes can be set.</p> <p>NOTE: Each Stand-alone Access Code programmed reduces the possible number of Directory Entries by one.</p>	<p>Step 1 Enter Function Code 31, then press #.</p> <div style="border: 1px solid black; padding: 2px; text-align: center;">ACCESS CODE:</div> <p>Step 2 Enter the new 4-digit Stand-alone Access Code, then press #.</p> <div style="border: 1px solid black; padding: 2px; text-align: center;">ACCESS CODE:</div> <p>Step 3 Enter the new 4-digit Stand-alone Access Code again for verification</p> <p>Step 4 Press #.</p>	<p>Step 1 Enter Function Code 31 and press #, one short beep sounds.</p> <p>Step 2 Enter the new 4-digit Stand-alone Access Code, press #, one short beep sounds.</p> <p>Step 3 Enter the new 4-digit Stand-alone Access Code again for verification.</p> <p>Step 4 Press #, two short beeps sound.</p>
<p style="text-align: center;">33</p> <p style="text-align: center;">DELETE A STAND-ALONE ACCESS CODE</p> <p>Deletes a single existing Stand-alone Access Code.</p>	<p>Step 1 Enter Function Code 33, then press #.</p> <div style="border: 1px solid black; padding: 2px; text-align: center;">ACCESS CODE:</div> <p>Step 2 Enter the 4-digit Stand-alone Access Code to delete, then press #.</p> <div style="border: 1px solid black; padding: 2px; text-align: center;">ACCESS CODE:</div> <p>Step 3 Enter the 4-digit Stand-alone Access Code to delete again for verification</p> <p>Step 4 Press #.</p>	<p>Step 1 Enter Function Code 33 and press #, one short beep sounds.</p> <p>Step 2 Enter the 4-digit Stand-alone Access Code to delete, press #, one short beep sounds.</p> <p>Step 3 Enter the 4-digit Stand-alone Access Code to delete again for verification.</p> <p>Step 4 Press #, two short beeps sound.</p>

FUNCTION CODE	LOCAL PROGRAMMING	TELEPHONE PROGRAMMING
<p style="text-align: center;">34</p> <p style="text-align: center;">COPY ALL MASTER MEMORY TO SUB-UNITS</p> <p>To synchronize programming in multi-unit installations, all system data can be copied from the master unit to selected sub-units. This data includes the Directory Entries, Stand-alone Access Codes, and all system option settings (except the sub-unit number).</p> <p>NOTE: This utility command can only be performed from the "master" unit.</p> <p>⚠ CAUTION: This utility command will overwrite ALL data in the sub-unit(s) selected.</p>	<p>Step 1 Enter Function Code 34, then press #.</p> <div style="border: 1px solid black; padding: 2px; width: fit-content; margin: 5px auto;">UNITS:</div> <p>Step 2 Enter the number(s) (2, 3, and/or 4) of all the sub-units to copy the data to, then press #.</p> <div style="border: 1px solid black; padding: 2px; width: fit-content; margin: 5px auto;">ARE YOU SURE ? 5</div> <p>Step 3 Enter 5 for verification, then press #.</p> <p style="text-align: center;">- OR -</p> <p>Enter * to cancel this command.</p> <p>NOTE: Function Codes 7 and 8 must be programmed before this command will operate.</p>	<p>Step 1 Enter Function Code 34 and press #, one short beep sounds.</p> <p>Step 2 Enter the number(s) (2, 3, and/or 4) of all the sub-units to copy the data to, then press #, one short beep sounds.</p> <p>Step 3 Enter 5 for verification, then press #, two short beeps sound. (Any entry other than 5# will cancel the command.)</p> <p>NOTE: To allow for multi-unit network communications, when executing this command remotely over the telephone, the system will disconnect your call after Step #3 then copy the data from the master unit to the sub-units.</p>
<p style="text-align: center;">35</p> <p style="text-align: center;">DISPLAY/CLEAR SYSTEM ERRORS</p> <p>The system's power indicator will flash if any system errors occur. These errors include loss of AC power and low backup battery. In multi-unit installations, the master unit logs communication errors with sub-units.</p>	<p>Step 1 Enter Function Code 35, then press #.</p> <div style="border: 1px solid black; padding: 2px; width: fit-content; margin: 5px auto;">(ERROR MESSAGE)</div> <p>If there are any errors, they will be displayed. Possible error messages are:</p> <div style="border: 1px solid black; padding: 2px; width: fit-content; margin: 5px auto;">LOW BATTERY</div> <div style="border: 1px solid black; padding: 2px; width: fit-content; margin: 5px auto;">NO AC</div> <div style="border: 1px solid black; padding: 2px; width: fit-content; margin: 5px auto;">COMMUNICATION ERROR UNIT #</div> <p>Step 2 Press # to display the next error message (if any).</p> <div style="border: 1px solid black; padding: 2px; width: fit-content; margin: 5px auto;">CLEAR ERROR LOG? YES ENTER 5</div> <p>Step 3 After the last error message, the option to clear the error log will be displayed. Enter 5 and press # to clear the log, or just press # to keep the log and exit.</p>	<p>NOT AVAILABLE</p>
<p style="text-align: center;">37</p> <p style="text-align: center;">POLL SUB-UNITS</p> <p>In multi-unit installations, this utility command will instruct the master unit to poll (request and receive communications) the sub-units. This command is used for testing purposes only.</p>	<p>Step 1 Enter Function Code 37, then press #.</p> <div style="border: 1px solid black; padding: 2px; width: fit-content; margin: 5px auto;">UNITS RESPONDING</div> <p>Step 2 The display will show the numbers of sub-units that responded error free on the first try. Press * to exit.</p>	<p>Step 1 Enter Function Code 37 and press #.</p> <p>If all sub-units respond error free, three short beeps will sound.</p> <p>If any sub-units don't respond error free, two long beeps will sound.</p>
<p style="text-align: center;">38</p> <p style="text-align: center;">SYSTEM DISPLAY LANGUAGE</p> <p>The factory default language is English. Three other languages can be selected as the language for the user and programming displays.</p> <p>NOTE: The system supports one display language at a time.</p>	<p>Step 1 Enter Function Code 38, then press #.</p> <div style="border: 1px solid black; padding: 2px; width: fit-content; margin: 5px auto;">LANGUAGE: 1-4</div> <p>Step 2 Enter:</p> <p style="margin-left: 20px;">1 for English (Default).</p> <p style="margin-left: 20px;">2 for Spanish.</p> <p style="margin-left: 20px;">3 for French.</p> <p style="margin-left: 20px;">4 for Portuguese.</p> <p>Step 3 Press #.</p>	<p>NOT AVAILABLE</p>

FUNCTION CODE	LOCAL PROGRAMMING	TELEPHONE PROGRAMMING
<p style="text-align: center;">46</p> <p style="text-align: center;">DISPLAY SYSTEM INFORMATION</p> <p>The Model number and firmware version installed in the AE-100 can be displayed.</p>	<p>Step 1 Enter Function Code 46, then press #.</p> <div style="border: 1px solid black; padding: 2px; margin: 5px 0; text-align: center;">MODEL AE-100 VER X.X</div> <p>Step 2 The display will show the model number and firmware version number of the firmware installed in the unit.</p> <p>Step 3 Press #.</p>	<p>NOT AVAILABLE</p>
<p style="text-align: center;">50</p> <p style="text-align: center;">TOTAL MEMORY RESET</p> <p>This command will erase all data and restore the factory settings.</p> <p>⚠ CAUTION: This utility command will erase all the data in the unit.</p>	<p>Step 1 Enter Function Code 50, then press #.</p> <div style="border: 1px solid black; padding: 2px; margin: 5px 0; text-align: center;">1 TO CONFIRM:</div> <p>Step 2 Enter 1 to confirm the reset.</p> <p style="text-align: center;">- OR -</p> <p>Enter * to cancel this command.</p>	<p>NOT AVAILABLE</p>
<p style="text-align: center;">70</p> <p style="text-align: center;">MAXIMUM VISITOR TALK TIME</p> <p>If for some reason the resident does not press the telephone keys to grant or deny access or does not hang up, the system will automatically disconnect the visitor after 60 seconds.</p> <p>At ten and five seconds before the disconnect a tone will sound on the telephone to remind the resident of the pending disconnect. The resident can extend the talk time by pressing the # key on their telephone. The disconnect time can be adjusted from 10-180 seconds.</p>	<p>Step 1 Enter Function Code 70, then press #.</p> <div style="border: 1px solid black; padding: 2px; margin: 5px 0; text-align: center;">TALK TIME: 060</div> <p>Step 2 The display will show the current talk time setting. Enter the new talk time (010-180 seconds).</p> <p>Step 3 Press #.</p>	<p>Step 1 Enter Function Code 70 and press #, one short beep sounds.</p> <p>Step 2 Enter the new talk time (010-180 seconds) and press #, two short beeps sound.</p> <p>Step 3 Press #, two short beeps sound</p>
<p style="text-align: center;">71</p> <p style="text-align: center;">ACCESS RELAY ACTIVATION TIME</p> <p>The factory setting will cause the access relay to activate for 4 seconds. The activation time can be set from 4-99 seconds to accommodate different types of access control devices.</p>	<p>Step 1 Enter Function Code 71, then press #.</p> <div style="border: 1px solid black; padding: 2px; margin: 5px 0; text-align: center;">OPEN TIME: 4</div> <p>Step 2 The display will show the current access relay activation time setting. Enter the new access relay activation time (04-99 seconds).</p> <p>Step 3 Press #.</p>	<p>Step 1 Enter Function Code 71 and press #, one short beep sounds.</p> <p>Step 2 Enter the new access relay activation time (04-99 seconds).</p> <p>Step 3 Press #, two short beeps sound.</p>
<p style="text-align: center;">72</p> <p style="text-align: center;">KEYPAD LOCKOUT COUNT</p> <p>The system counts the number of invalid Access Codes entered at the keypad. If the invalid entries exceeds the lockout count number, the keypad is locked out for 90 seconds. The factory setting for the lockout count is three. The lockout value can be from one to nine.</p>	<p>Step 1 Enter Function Code 72, then press #.</p> <div style="border: 1px solid black; padding: 2px; margin: 5px 0; text-align: center;">LOCK-OUT COUNT: 3</div> <p>Step 2 The display will show the current lockout count. Enter the new lockout count (1-9 tries).</p> <p>Step 3 Press #.</p>	<p>Step 1 Enter Function Code 72 and press #, one short beep sounds.</p> <p>Step 2 Enter the new lockout count (1-9 tries).</p> <p>Step 3 Press #, two short beeps sound</p>

FUNCTION CODE	LOCAL PROGRAMMING	TELEPHONE PROGRAMMING
<p>74</p> <p>AUTOMATIC TELEPHONE ANSWER</p> <p>The factory setting will allow the system to detect a ring signal on the telephone line and answer the call.</p> <p>NOTE: The automatic answer feature can be turned off, although remote programming, remote access control by residents, and resident call-back features will no longer function</p>	<p>Step 1 Enter Function Code 74, then press #.</p> <div style="border: 1px solid black; padding: 2px; width: fit-content; margin: 5px auto;">AUTO-ANSWER=1:</div> <p>Step 2 The display will show the auto answer setting. Enter 0 to disable auto answer. Enter 1 to enable auto answer (default).</p> <p>Step 3 Press #.</p>	<p>NOT AVAILABLE</p>
<p>75</p> <p>SPEAKER CHIRP ON KEYSTROKES</p> <p>The factory setting will cause the speaker to chirp when each key on the keypad is pressed. Alternately, the speaker chirp can be turned off.</p>	<p>Step 1 Enter Function Code 75, then press #.</p> <div style="border: 1px solid black; padding: 2px; width: fit-content; margin: 5px auto;">BEEP ON=1 OFF=0</div> <p>Step 2 Enter 0 to turn the keystroke chirps OFF. Enter 1 to turn the keystroke chirps ON (default).</p> <p>Step 3 Press #.</p>	<p>Step 1 Enter Function Code 75 and press #, one short beep sounds.</p> <p>Step 2 Enter 0 to turn the keystroke chirps OFF. Enter 1 to turn the keystroke chirps ON.</p> <p>Step 3 Press #, two short beeps sound.</p>
<p>76</p> <p>SPEAKER TONE ON ACCESS RELAY ACTIVATION</p> <p>The factory setting will cause the speaker to sound a tone for two seconds when the access relay is activated. Alternately, the tone can be turned off.</p>	<p>Step 1 Enter Function Code 76, then press #.</p> <div style="border: 1px solid black; padding: 2px; width: fit-content; margin: 5px auto;">UNLOCK BEEP(1,0)</div> <p>Step 2 Enter 0 to turn the relay tone OFF. Enter 1 to turn the relay tone ON (default).</p> <p>Step 3 Press #.</p>	<p>Step 1 Enter Function Code 76 and press #, one short beep sounds.</p> <p>Step 2 Enter 0 to turn the relay tone OFF. Enter 1 to turn the relay tone ON.</p> <p>Step 3 Press #, two short beeps sound.</p>
<p>77</p> <p>RESIDENT CONTROL OF ACCESS RELAY</p> <p>The factory setting allows the resident to activate the access relay by pressing the 9 key on their telephone when a call from the AE-100 is received. This feature can be disabled. Disabling this feature will only allow access by using resident Access Codes and Stand-alone Access Codes at the unit's keypad.</p>	<p>Step 1 Enter Function Code 77, then press #.</p> <div style="border: 1px solid black; padding: 2px; width: fit-content; margin: 5px auto;">ENA=1 DISA=0:</div> <p>Step 2 Enter 0 to disable resident control of the access relay. Enter 1 to enable resident control of the access relay (default).</p> <p>Step 3 Press #.</p>	<p>NOT AVAILABLE</p>

FUNCTION CODE	LOCAL PROGRAMMING	TELEPHONE PROGRAMMING
<p style="text-align: center;">91</p> <p style="text-align: center;">EXIT PROGRAMMING MODE</p> <p>Entering this command number will cause the unit to exit programming mode and return to normal operation.</p>	<p>Step 1 To exit programming mode, enter Function Code 91, then press #.</p> <p>NOTE: The AE-100 will automatically exit Programming Mode after five minutes of programming inactivity</p>	<p>Step 1 To exit programming mode, enter Function Code 91.</p> <p>Step 2 Press #, three short beeps sound.</p>
<p style="text-align: center;">93</p> <p style="text-align: center;">DELETE ALL STAND-ALONE ENTRY CODES</p> <p>This utility command will permanently erase all Stand-alone Access Codes.</p> <p>⚠ CAUTION: This utility command will erase ALL the Stand-alone Access Codes in the unit.</p>	<p>Step 1 Enter Function Code 93, then press #.</p> <div style="border: 1px solid black; padding: 2px; width: fit-content; margin: 5px auto;">ENTER FUNCTION#</div> <p>Step 2 Enter the Function Code 93 again for verification, then press #.</p>	<p>NOT AVAILABLE</p>
<p style="text-align: center;">95</p> <p style="text-align: center;">TENANT CALL-BACK</p> <p>The tenant call-back feature allows the AE-100 to answer the telephone and switch to speakerphone mode if the telephone call is within 60 seconds of the last use of the AE-100. This feature gives residents the capability to call a visitor back in case of a recently missed call. The factory setting has this feature disabled. Alternately, this feature can be enabled.</p> <p>NOTE: The Automatic Telephone Answer feature (Function Code #74) must also be enabled for this feature to function.</p>	<p>Step 1 Enter Function Code 95, then press #.</p> <div style="border: 1px solid black; padding: 2px; width: fit-content; margin: 5px auto;">TENANT CALL BK=#</div> <p>Step 2 The display will show the current setting. Enter 0 to disable tenant call-back (default). Enter 1 to enable tenant call-back.</p> <p>Step 3 Press #.</p> <p>NOTE: This feature can only be used in single unit installations.</p>	<p>Step 1 Enter Function Code 95 and press #, one short beep sounds.</p> <p>Step 2 Enter 0 to disable tenant call-back. Enter 1 to enable tenant call-back</p> <p>Step 3 Press #, two short beeps sound.</p>

System Adjustments

The factory settings are sufficient for most installations. The system can be adjusted to customize the installation.

Digital Speech Volume Adjustment

The sound level of the tones and digital voice that the system produces can be adjusted.

1. Locate the **DIGITAL SPEECH VOLUME** adjustment on the main circuit board.
2. Press the \odot key test the digital speech level. Turn the **DIGITAL SPEECH VOLUME** control adjustment *clockwise* for more volume, *counterclockwise* for less volume.

Speakerphone Volume Adjustment

If the resident's voice from the speaker is too loud or not loud enough, the speaker's volume can be adjusted.

◆ **NOTE:** Adjusting the **SPEAKERPHONE VOLUME** too high will prevent proper operation. This control only affects the speaker volume, not the volume from the microphone.

1. Locate the **SPEAKERPHONE VOLUME** adjustment on the main circuit board.
2. Make a Directory Code call to test the speaker volume. While listening to the resident's voice, turn the adjustment *clockwise* for more volume, *counterclockwise* for less volume.

Display Contrast Adjustment

If the lighting in the area or the viewing angle of the display in the installation causes the display to look too dark or too light, the display's contrast can be adjusted.

1. Locate the **DISPLAY CONTRAST** adjustment on the main circuit board.
2. Turn the adjustment clockwise and counterclockwise until display has the best visibility.

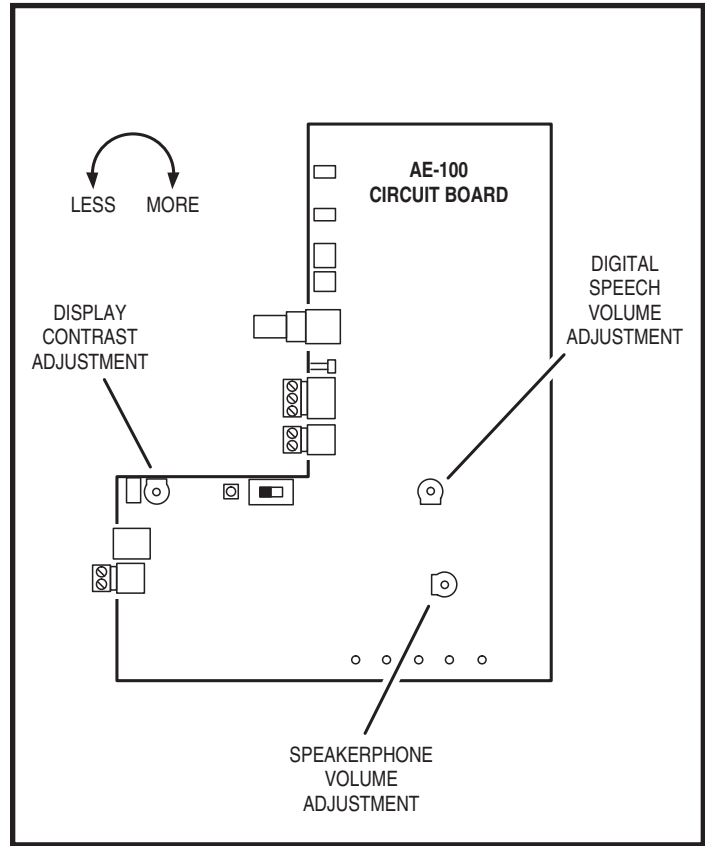

System Diagnostics

Several components on the main circuit board are for monitoring the system during operation. When calling for technical assistance, Linear's Technical Services Department may ask the installer to use these components to diagnose the system.

On-board Indicators

Five LED indicators are on the main circuit board. Refer to the figure for the location of each indicator.

- **POWER** lights when power is present at the power terminals, flashes after diagnostic failure or communication failure (to clear indicator, see Function or PPN #35).
- **PHONE** flashes when the system has the incoming telephone line seized (off-hook), lights when the system is not seizing the telephone line (on-hook), off when there is no telephone line connection.
- **STATUS** lights when the unit has seized the telephone line or answered the telephone.
- **BATTERY** lights when the backup battery voltage is OK, flashes when the backup battery is charging, off if no backup battery is installed.
- **RELAY** lights when the access relay is energized.

Reset Button

Pressing the **RESET** button will reboot the system's micro controller. **NO SYSTEM INFORMATION WILL BE ERASED.**

After the system reset, the system's master code will be displayed.

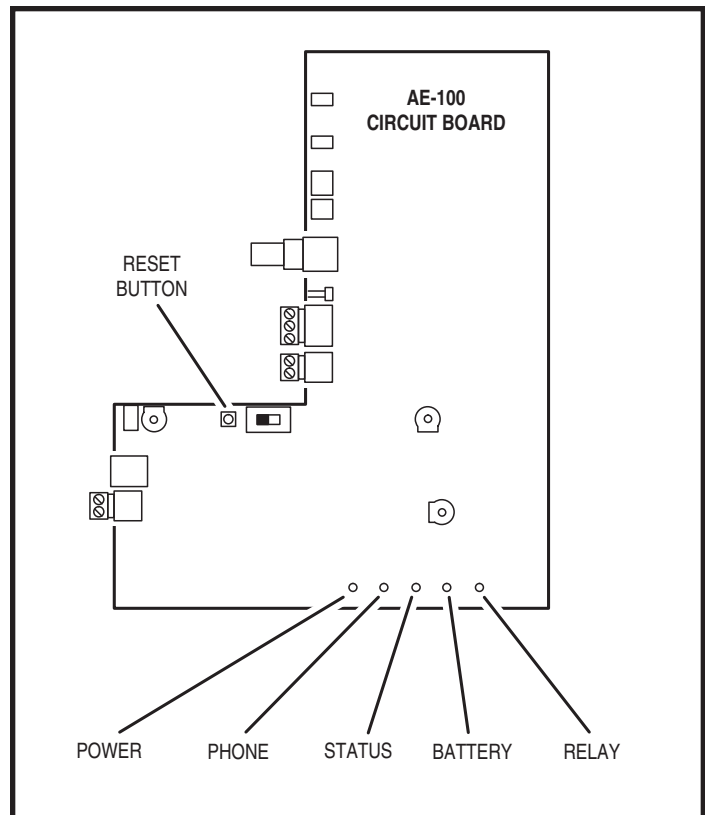

AE-100 Operation

Requesting Access with a Visitor Call

- If the visitor already knows the resident's Directory Code number, they can press **#** first, then enter the Directory Code number to call the resident.
- If the visitor doesn't know the residents Directory Code number, they can scroll through the alphabetical directory entries by pressing **▲** or **▼**.
 - Pressing **▲** scrolls from A-Z.
 - Pressing **▼** scrolls from Z-A.
 - Holding down the **▲** or **▼** keys will scroll the display faster.
- When the visitor finds the resident's name and Directory Code number, they can press **☎** to call the resident.
- The system dials the resident's Telephone Number to establish 2-way communications.
- ◆ **NOTE:** The resident's Telephone Number will never be displayed to the visitor.
- The resident answers the call and converses with the visitor to determine if access should be granted.
- The resident can use their telephone's keypad to grant access activating the access relay by pressing **9**. After access is granted, the system will disconnect the visitor and resident call.
- The resident can disconnect the visitor without granting access by pressing ***** or by hanging up.
- ◆ **NOTE:** Disconnecting by hanging up is not recommended. The system will keep the telephone line seized until the maximum visitor talk time timer runs out (the factory default is 60 seconds).
- The length of time the visitor is allowed to talk can be programmed from 10-180 seconds. At ten and five seconds before the disconnect a tone will sound on the telephone to remind the resident of the pending disconnect. To restart the talk timer, the resident can press **#** on their telephone.

Requesting Access with an Entry Code

Residents and authorized personnel have up to 40 seconds to key in their Entry Code.

1. Press ***** first to clear the keypad (optional), then enter the Entry Code.
2. When a correct code is entered, the access relay will activate.
 - Directory Entry Codes or Stand-alone Entry Codes can be used.
 - Up to eight seconds are allowed between each keystroke.
 - All digits of the Entry Code must be entered.
 - Example: The Entry Code length is four digits, and the code is 0042, the user must enter "0 0 4 2".
 - If a mistake is made, pressing the ***** key will reset the keypad. The correct code can then be re-entered.
 - If the number of incorrect codes entered exceeds the keypad lockout count, the keypad will be locked and not accept any entries for 90 seconds.

Resident Call-back

If the resident call-back feature is enabled, resident's can call the AE-100 to talk to a visitor and grant access. The call-back must be made within 60 seconds after the visitor's missed call.

1. The resident dials the telephone number of the system within 60 seconds of its last use.
2. The system answers, and sounds one short beep.
3. After talking to the visitor, the resident can press their entry code to grant access, or the resident can press star to deny access.

VISITOR ACCESS

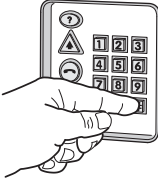

1. IF THE VISITOR ALREADY KNOWS THE RESIDENT'S DIRECTORY CODE, PRESS # AND ENTER THE RESIDENT'S DIRECTORY CODE, THE SYSTEM WILL CALL THE RESIDENT

- OR -

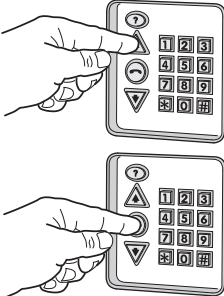

1. PRESS UP OR DOWN BUTTONS TO VIEW THE NAMES IN THE DIRECTORY (HOLDING DOWN THE BUTTON MAKES THE DIRECTORY SCROLL FASTER)

2. WHEN NAME IS FOUND, PRESS THE CALL BUTTON

- THEN -

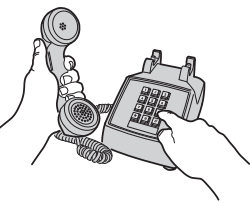

1. AFTER THE CALL IS ANSWERED, THE VISITOR CONVERSES WITH THE RESIDENT

2. THE RESIDENT GRANTS OR DENIES ACCESS

TO GRANT ACCESS, PRESS **9**

- OR -

TO DENY ACCESS, PRESS *****

ENTRY CODE ACCESS

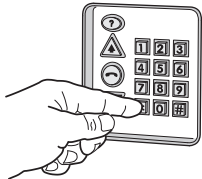

PRESS STAR FIRST TO CLEAR THE KEYPAD (OPTIONAL), THEN KEY IN A DIRECTORY ENTRY CODE OR STAND-ALONE ENTRY CODE

UP TO 8 SECONDS ARE ALLOWED BETWEEN EACH KEYSTROKE



UP TO 40 SECONDS ARE ALLOWED TO KEY IN THE ENTIRE ENTRY CODE

ALL FOUR DIGITS MUST BE ENTERED, INCLUDING LEADING ZEROS

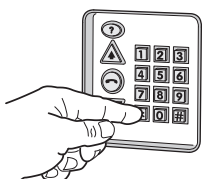

IF A MISTAKE IS MADE, PRESS STAR KEY TO START OVER

THE KEYPAD WILL LOCKOUT AFTER TOO MANY INCORRECT ENTRIES

WHEN A CORRECT CODE IS ENTERED, THE ACCESS RELAY WILL ACTIVATE

RESIDENT CALL-BACK



1. CALL THE SYSTEM WITHIN 60 SECONDS OF A VISITOR'S MISSED CALL
2. THE SYSTEM ANSWERS AND SOUNDS ONE SHORT BEEP
3. CONVERSE WITH THE VISITOR
4. TO GRANT ACCESS, KEY IN AN ENTRY CODE

- OR -

TO DENY ACCESS, PRESS *****

Specifications

MECHANICAL

Case dimensions: 9-3/4" W x 11-3/4" H x 3-1/2" D

ELECTRICAL

Input Power: 16 VAC from supplied plug-in transformer

Current Consumption: < 200 mA idle, < 500 mA operating

Backup Battery: 12 Volt sealed lead-acid gel cell (not included)
Built-in charger with up to 7 A/H battery capacity

Access Relay: Form "C" (Normally Open & Normally Closed)
10 Amps @ 30 Volts AC maximum
7 Amps @ 30 Volts DC maximum

Display: Two-line 16-character LCD with LED backlight

Dialing: DTMF

ENVIRONMENTAL

Temperature: -22°F to 149°F (-30°C to 65°C)

Humidity: 5% to 95% non-condensing

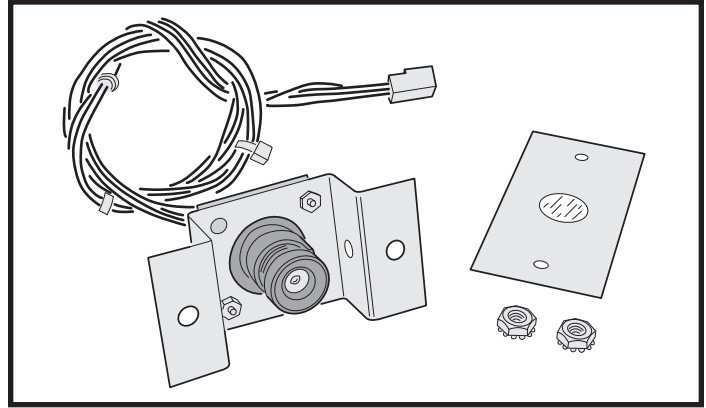

Model CCM-1 Color CCTV Camera (P/N ACP00904)

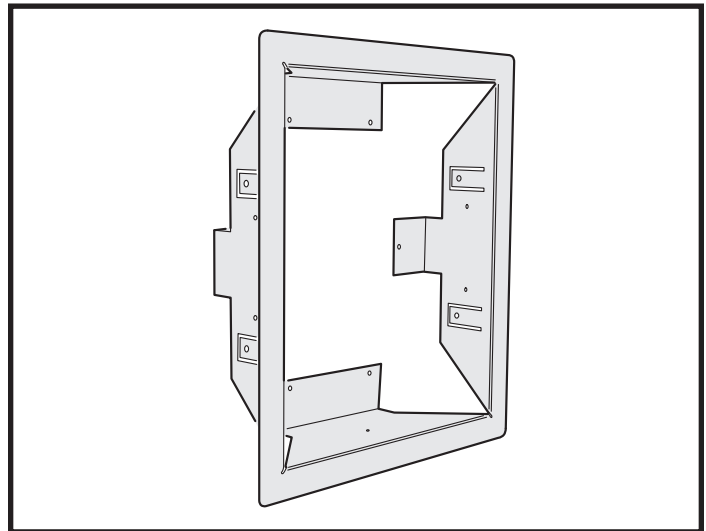

Model TR-100 Trim Ring (P/N ACP00941)

Dimension Drawing

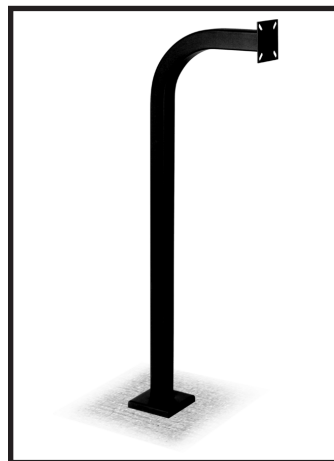
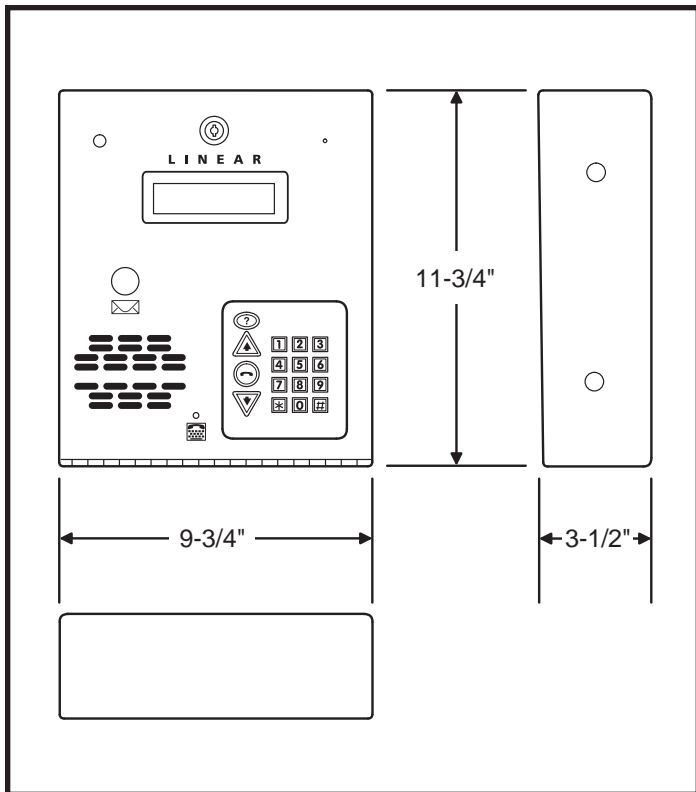

Model GNC-1 Curb-mount
Gooseneck (P/N ACP00906)

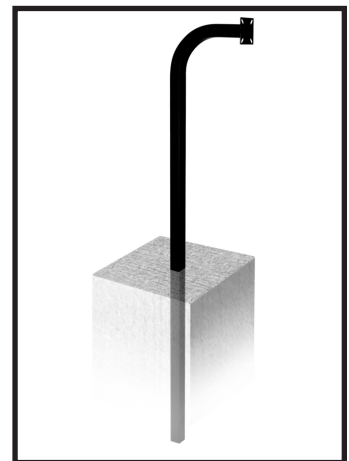

Model GNB-1 Burial-mount
Gooseneck (P/N ACP00907)

Troubleshooting

System completely dead

1. No power from transformer. Check voltage at AE-100 transformer terminals.
2. Verify that terminal blocks are firmly plugged into circuit board.

Buzz on speaker

1. Check for 16 volt AC power shorted to wiring conduit.
2. Check for telephone line shorted to ground.
3. Verify that telephone wires are twisted pair.
4. Verify that the AE-100 is connected to earth ground.
5. Check 16 VAC voltage at AE-100 transformer terminals.

Buzz on telephone line

1. Disconnect 16 VAC wires from terminal strip, if buzz goes away, one side of the transformer wires is grounded.
2. Check all connections for any shorts to ground.

System will not answer an incoming call

1. Automatic telephone answer disabled.
2. AE-100 telephone line trouble.

Keypad will not activate a relay

1. Entry code is not assigned.
2. Keypad may be in lockout from too many incorrect attempts. Wait 90 seconds for lockout to clear and try again.

Resident's Telephone does not ring when a visitor calls

1. Resident's Telephone Number programmed incorrectly.
2. Check AE-100 telephone line.
3. Call resident from another line or cell phone to determine if the resident's telephone is working.

Linear Limited Warranty

This Linear product is warranted against defects in material and workmanship for twenty-four (24) months. This warranty extends only to wholesale customers who buy direct from Linear or through Linear's normal distribution channels. Linear does not warrant this product to consumers. Consumers should inquire from their selling dealer as to the nature of the dealer's warranty, if any. **There are no obligations or liabilities on the part of Linear LLC for consequential damages arising out of or in connection with use or performance of this product or other indirect damages with respect to loss of property, revenue, or profit, or cost of removal, installation, or reinstallation.** All implied warranties, including implied warranties for merchantability and implied warranties for fitness, are valid only until the warranty expires. **This Linear LLC Warranty is in lieu of all other warranties express or implied.**

All products returned for warranty service require a Return Product Authorization Number (RPA#). Contact Linear Technical Services at 1-800-421-1587 for an RPA# and other important details.

FCC Notice

Changes or modifications not expressly described in this manual or approved by the manufacturer could void the user's authority to operate the equipment.

This equipment has been tested and found to comply with the limits for a Class B digital device, pursuant to Part 15 of the FCC Rules. These limits are designed to provide reasonable protection against harmful interference in a residential installation. This equipment generates, uses and can radiate radio frequency energy and, if not installed and used in accordance with the instructions, may cause harmful interference to radio communications. However, there is no guarantee that interference will not occur in a particular installation. If this equipment does cause harmful interference to radio or television reception, which can be determined by turning the equipment off and on, the user is encouraged to try to correct the interference by one or more of the following measures:

- Reorient or relocate the receiving antenna.
- Increase the separation between the equipment and receiver.
- Connect the equipment into an outlet on a circuit different from that to which the receiver is connected.
- Consult the dealer or an experienced radio/TV technician for help.

