

AM-KP

Access Control Keypad

Installation Instructions

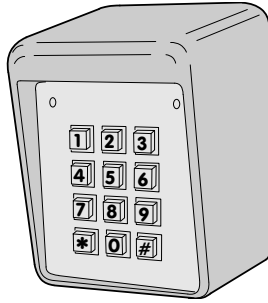

Linear
Building On Innovation.

USA & Canada (800) 421-1587 & (800) 392-0123
(760) 438-7000 - Toll Free FAX (800) 468-1340
www.linearcorp.com

INTRODUCTION

The AM-KP keypad is designed for use with Linear's AE1000Plus, AE2000Plus, and AM3Plus access control systems. The keypad is housed in a rugged cast aluminum enclosure. The die-cast keys have bright, easy-to-read yellow graphics. Each key has a positive tactile "click" feel when pressed. An internal sounder signals when a key is pressed.

The keypad can be mounted to a pedestal or directly to a wall. A keylock secures the keypad to the mounting backplate.

An incandescent panel lamp lights the keypad for nighttime use. Red, green and yellow indicators show power, access and lockout conditions.

The AM-KP is normally powered from the controller, or can be powered locally from a 12 VDC power supply. Robust static and lightning protection circuits safeguard the keypad's electronics.

A rotary switch selects the keypad's PBUS device address. Each PBUS device connected to the controller must be set to a different PBUS device address.

1. AM-KP FEATURES

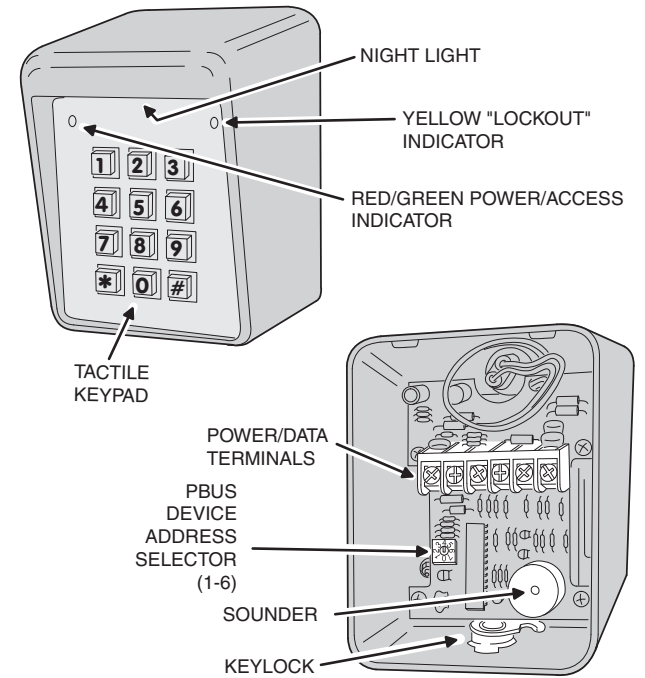

2. PLAN INSTALLATION

PLAN THE LOCATIONS FOR CONTROL AND REMOTE DEVICES

PLAN CABLE RUNS BETWEEN CONTROL AND REMOTE DEVICES

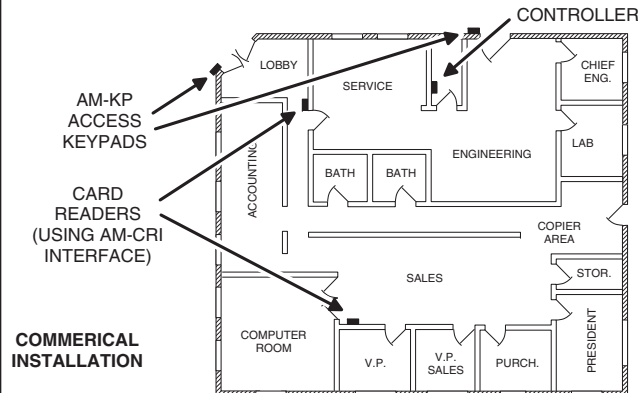
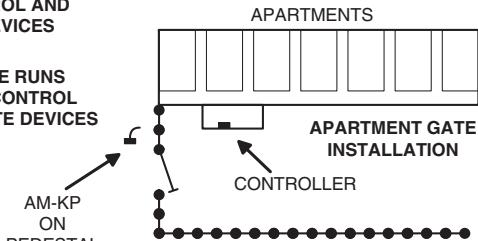

3. MOUNT BACKPLATE

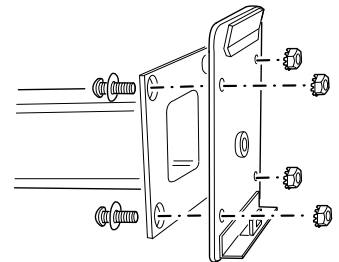
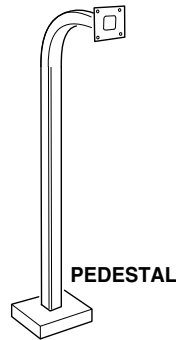

WALL MOUNTING

USE CONCRETE WEDGE ANCHORS OR MOLLY ANCHORS

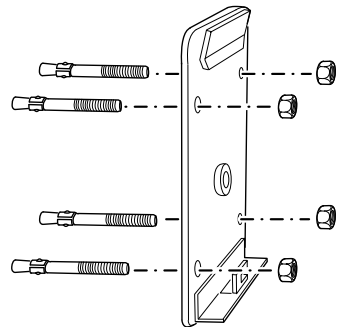

4. ROUTE CABLE

EACH AM-KP KEYPAD EQUALS 9 LOAD UNITS

CABLE LENGTH FORMULA FOR EACH KEYPAD USED IN SYSTEM

CABLE RUN	CABLE TYPE	FORMULA
300 FEET MAXIMUM	BELDEN 9931 (24 AWG)	FEET x LOAD UNITS < 3,000 MAXIMUM
500 FEET MAXIMUM	WEICO 9405 (20 AWG)	FEET x LOAD UNITS < 10,000 MAXIMUM

HOMERUN WIRE EACH KEYPAD (1000 FEET WIRE MAXIMUM ALLOWED IN SYSTEM)

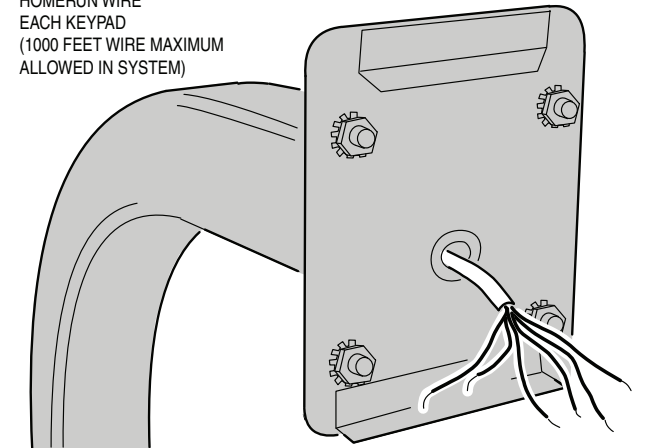

5. CONNECT CABLE

FOLLOW THIS WIRING DIAGRAM TO CONNECT THE KEYPAD TO THE CONTROLLER

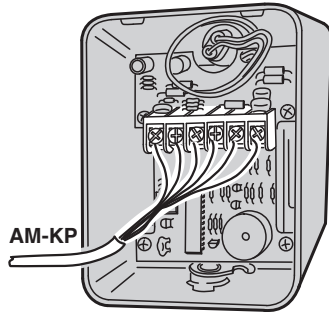
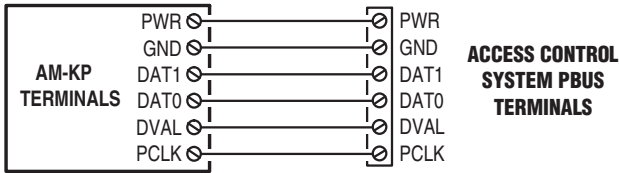

FOR LOCAL POWER, DISCONNECT RED WIRE FROM "PWR" CONNECTION ON AM-KP AND CONNECT EXTERNAL 12 VDC SUPPLY (+ TO PWR & - TO GND)
NOTE: CONTROLLER ± MUST BE CONNECTED TO AM-KP "GND"

6. SET PBUS DEVICE ADDRESS

USE A SMALL SCREWDRIVER TO SET THE PBUS DEVICE ADDRESS SWITCH

EACH PBUS DEVICE MUST BE SET TO A UNIQUE NUMBER FROM 1 TO 6

ARROW ON SLOT POINTS TO NUMBER

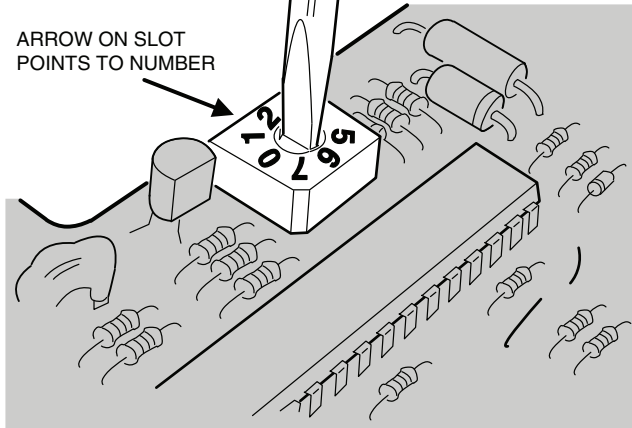

7. SECURE & LOCK CASE

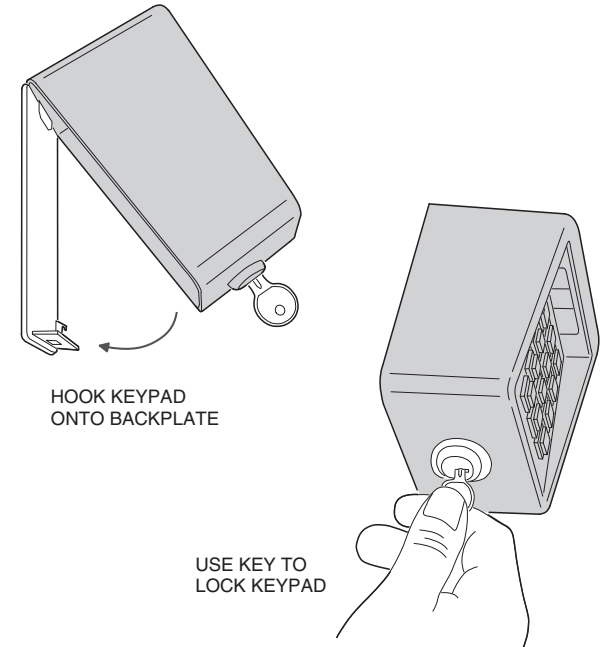

HOOK KEYPAD ONTO BACKPLATE

USE KEY TO LOCK KEYPAD

8. PROGRAM SYSTEM

PROGRAM THE CONTROLLER TO CONFIGURE THE REMOTE RECEIVER

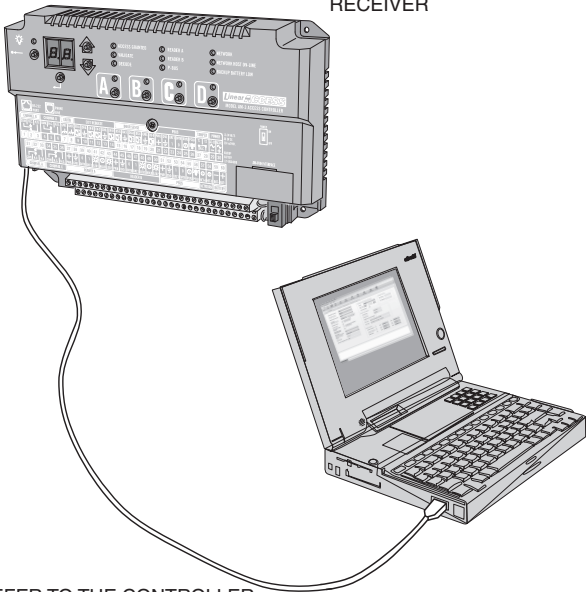

REFER TO THE CONTROLLER PROGRAMMING INSTRUCTIONS FOR DETAILS

9. TEST KEYPAD

1. RED INDICATOR SHOULD BE LIT
2. ENTER VALID CODE
3. RED INDICATOR SHOULD TURN GREEN AND PROGRAMMED RELAY IN THE CONTROLLER SHOULD ACTIVATE

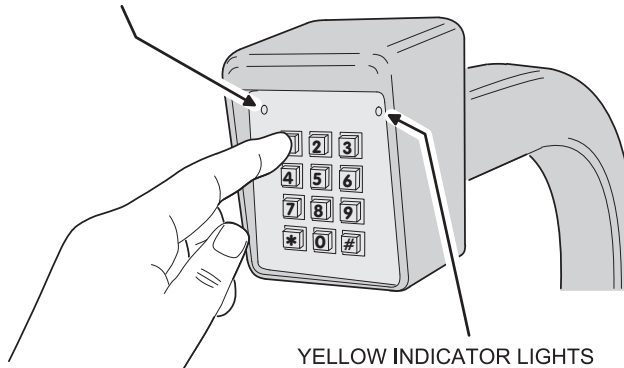

YELLOW INDICATOR LIGHTS WHEN KEYPAD IS LOCKED OUT OR BUSY

LINEAR LIMITED WARRANTY

This Linear product is warranted against defects in material and workmanship for twelve (12) months. **This warranty extends only to wholesale customers** who buy direct from Linear or through Linear's normal distribution channels. **Linear does not warrant this product to consumers.** Consumers should inquire from their selling dealer as to the nature of the dealer's warranty, if any. **There are no obligations or liabilities on the part of Linear LLC for consequential damages arising out of or in connection with use or performance of this product or other indirect damages with respect to loss of property, revenue, or profit, or cost of removal, installation, or reinstallation.** All implied warranties, including implied warranties for merchantability and implied warranties for fitness, are valid only until the warranty expires. **This Linear LLC Warranty is in lieu of all other warranties express or implied.**

All products returned for warranty service require a Return Product Authorization Number (RPA#). Contact Linear Technical Services at 1-800-421-1587 for an RPA# and other important details